

# **Appendix 4**

## **Geotechnical Evaluation**

**Sunset Crossings Residential Project**  
**Initial Study**



**DESIGN-LEVEL GEOTECHNICAL EXPLORATION  
PROPOSED 50-ACRE RESIDENTIAL DEVELOPMENT  
SOUTH OF COTTONWOOD AVENUE  
NORTH OF ALESSANDRO BOULEVARD  
MORENO VALLEY, CALIFORNIA**

**Prepared For** **HIGHPOINTE MV 1 LLC**  
530 TECHNOLOGY, SUITE 100  
IRVINE, CALIFORNIA 92618

**Prepared By** **LEIGHTON AND ASSOCIATES, INC.**  
41715 ENTERPRISE CIRCLE, N SUITE103  
TEMECULA, CALIFORNIA 92590

Project No. 13169.003

May 19, 2022

---



May 19, 2022

Project No. 13169.003

Highpointe MV 1 LLC  
530 Technology, Suite 100  
Irvine, California 92618

Attention: Mr. Ross Yamaguchi, Senior Project Manager

**Subject: Design-Level Geotechnical Exploration  
Proposed 50-Acre Residential Development  
South of Cottonwood Avenue, North of Alessandro Boulevard  
Moreno Valley, California**

In accordance with your request and authorization, we provide this report documenting findings and conclusions of our site geotechnical exploration, pertinent to development of the subject property for residential use. Our study was undertaken to evaluate the general distribution and engineering characteristics of surface/subsurface earth units, and impacts of geologic hazards, and develop geotechnical recommendations for design and construction. A deposit of settlement-prone alluvium at the surface is considered the most significant geotechnical constraint due to its relatively high collapse potential, warranting over-excavation and recompaction to depths of 7 to 9 feet and 12 to 14 feet in north and south site areas, respectively. Provided recommendations presented herein are properly incorporated into project design and construction, the development project is considered suitable from a geotechnical perspective. Once final grading and foundation plans are available, our recommendations should be reviewed to verify conformance with those plans.

We appreciate the opportunity to work with you on this project. If you have any questions or if we can be of further service, please contact us at (866) LEIGHTON; or specifically at the telephone extensions or e-mail addresses listed below.

Respectfully submitted

LEIGHTON AND ASSOCIATES, INC.

Jeff L. Hull, CEG 2056  
Associate Geologist  
Ext. 4265, [jhull@leightongroup.com](mailto:jhull@leightongroup.com)



Simon Saiid, GE 2641  
Principal Engineer  
Ext. 8013, [ssaiid@leightongroup.com](mailto:ssaiid@leightongroup.com)



Distribution: (1) Addressee (PDF copy via email)

## TABLE OF CONTENTS

<b><u>Section</u></b>	<b><u>Page</u></b>
<b>1.0 INTRODUCTION .....</b>	<b>1</b>
1.1 Site Description and Proposed Development .....	1
1.2 Purpose and Scope .....	1
<b>2.0 GEOTECHNICAL AND GEOLOGIC FINDINGS .....</b>	<b>3</b>
2.1 Regional Geology .....	3
2.2 Site-Specific Geology .....	4
2.3 Groundwater Conditions .....	4
2.4 Expansive Soils .....	5
2.5 Soil Sulfate Content .....	5
2.6 Infiltration Testing .....	6
<b>3.0 GEOLOGIC AND SEISMIC HAZARD EVALUATION.....</b>	<b>8</b>
3.1 Faulting .....	8
3.2 Seismicity .....	8
3.3 Other Geologic Hazards.....	9
3.3.1 Liquefaction Potential .....	9
3.3.2 Seismically-Induced Settlement.....	10
3.3.3 Lateral Spreading.....	10
3.3.4 Slope Stability and Seismically Induced Landslides.....	10
3.4 Earthquake-Induced Flooding .....	10
3.5 Flooding .....	10
3.6 Land Subsidence .....	11
<b>4.0 SUMMARY OF FINDINGS AND CONCLUSIONS .....</b>	<b>12</b>
<b>5.0 RECOMMENDATIONS.....</b>	<b>13</b>
5.1 General Earthwork Considerations .....	13
5.1.1 Site Preparation.....	13
5.1.2 Remedial Grading .....	13
5.1.3 Fill Placement and Compaction .....	13
5.1.4 Shrinkage and Subsidence .....	14
5.1.5 Import Soils.....	14
5.1.6 Utility Trenches.....	14
5.1.7 Drainage .....	15
5.1.8 Slope Design and Construction .....	15
5.2 Foundation Design .....	16
5.2.1 Bearing and Lateral Pressures .....	16
5.2.2 Settlement .....	17
5.2.3 Vapor Retarder .....	17
5.3 Temporary Excavation and Shoring Design .....	18

5.4	Preliminary Pavement Design Parameters.....	18
5.5	Retaining Walls.....	19
5.6	Foundation Setback from Slopes.....	20
5.7	Concrete Flatwork .....	21
<b>6.0</b>	<b>GEOTECHNICAL CONSTRUCTION SERVICES .....</b>	<b>23</b>
<b>7.0</b>	<b>LIMITATIONS .....</b>	<b>24</b>
<b>8.0</b>	<b>REFERENCES .....</b>	<b>25</b>

### LIST OF TABLES

TABLE 1.	CORROSIVITY TEST RESULTS .....	5
TABLE 2.	MEASURED INFILTRATION RATE (UNFACTORED) .....	6
TABLE 3.	2019 CBC-BASED SEISMIC DESIGN PARAMETERS .....	9
TABLE 4.	PAVEMENT SECTION DESIGN .....	18
TABLE 5.	RETAINING WALL DESIGN EARTH PRESSURES (STATIC, DRAINED) .....	19
TABLE 6.	FOOTING SETBACKS .....	20

### Figures

Figure 1 –	Site Location Map	Rear of Text
Figure 2 –	Site Geotechnical Map	Rear of Text
Figure 3 –	Regional Geology Map	Rear of Text
Figure 4 –	Regional Fault Map	Rear of Text
Figure 5 –	Liquefaction Map	Rear of Text
Figure 6 –	Flood Hazard Zone Map	Rear of Text
Figure 7 –	Subsidence Map	Rear of Text

### Appendices

Appendix A –	Boring / Test Pit / Infiltration Test Logs
Appendix B –	Laboratory Test Results
Appendix C –	Seismic Design Data and Settlement Analyses
Appendix D –	General Earthwork and Grading Specifications for Rough Grading
Appendix E –	Retaining Wall Backfill and Subdrain Detail
Appendix F –	GBA Important Information About This Geotechnical Engineering Report

## 1.0 INTRODUCTION

### 1.1 Site Description and Proposed Development

The subject 50-acre property is located south of Cottonwood Avenue and North of Alessandro Boulevard in the City of Moreno Valley, California (N 33.9205, W - 117.1871). The site location and surrounding areas are depicted on attached Figure 1, *Site Location Map*. The property is currently vacant except for a few existing private ranch-style residential structures located within the north and eastern portions of the site. Surface elevations (El.) range from approximately El. 1640 feet above mean sea level (msl) in the northeast to El. 1590 feet msl in the south, manifest in about 50 vertical feet of overall relief. Offsite areas to the west are lightly developed for commercial and single-family residential use.

Our understanding of the project is based on review of the Moreno Valley Site Plan Exhibit prepared by Proactive Engineering Consultants dated March 17, 2022. The site is currently proposed to be developed as a tract of single-family homes with 241 individual lots. We anticipate that the homes will consist of typical 1- to 2-story wood-framed structures supported by conventional reinforced concrete slab-on-grade floors and/or shallow spread and continuous footings (no subterranean elements). Vehicular access will be accommodated by a series of internal access roads. Appurtenant improvements include a network of underground utilities, two ten foot deep water quality management basins, and approximately 3 acres of park space.

### 1.2 Purpose and Scope

The purpose of this exploration was to evaluate the onsite surface and subsurface soils conditions, and provide geotechnical recommendations for design and construction of the proposed development. More specifically, our scope of our work included the following:

- Literature Review – Review of published geologic maps and reports, and historical aerial photographs and topographic maps readily available on-line or within our in-house technical library. A list of these documents is presented in Section 8.0, *References*.
- Exploratory Borings and Test Pits – Advanced four (4) hollow-stem borings (LB-1 through LB-4) on the site, on March 4, 2022, extending to depths between 31.5 feet to 51.5 feet below the existing ground surface (bgs). Approximate boring locations are shown on Figure 2, *Site Geotechnical Map*. Copies of boring logs are presented in Appendix A, *Boring / Test Pit / Infiltration Test Logs*.

Bulk and relatively undisturbed drive samples were collected during drilling for the purpose of field description and geotechnical laboratory testing. The driven samples were obtained using a Modified California Ring sampler conducted in accordance with ASTM Test Method D3550. The samplers were driven for a total penetration of 18 inches using a 140-pound automatic hammer allowed to fall freely from a height of 30 inches. The number of blows per 6 inches of penetration was recorded.

In addition, four (4) exploratory test pits (TP-1 through TP-3, and TP-5) were excavated, logged, and sampled on March 4, 2022 using a rubber-tire backhoe to a maximum depth of approximately 5 feet bgs. Trench logs are presented in Appendix B, *Boring / Test Pit / Infiltration Test Logs*.

Each boring and test pit was logged in the field by a member of our technical staff under the direct supervision of a State of California Certified Engineering Geologist (CEG). Soil samples were reviewed and described in the field in accordance with the Unified Soil Classification System (USCS). Upon completion, the excavations were backfilled with soil cuttings.

- *Infiltration Testing*: For the purpose of infiltration testing, two additional hollow-stem auger borings (LP-1 and LP-2) were advanced near the location of proposed bio-retention basins on March 4, 2022, each to a depth of approximately 13 feet bgs. Results of the percolation testing are presented in Appendix A.
- *Laboratory Testing*: Representative soil samples obtained from the subsurface exploration program were selected for testing. A brief description of laboratory testing procedures and laboratory test results are presented in Appendix B, Geotechnical Laboratory Testing. Moisture content and in-situ density are presented within our boring logs (see Appendix A).
- *Engineering Evaluation* – Data collected was reviewed and analyzed by a Geotechnical Engineer (GE) and a Certified Engineering Geologist (CEG).
- *Report Preparation* – This report was prepared to document findings and conclusions, and provide design-level geotechnical recommendations addressing the currently proposed development concept.

## 2.0 GEOTECHNICAL AND GEOLOGIC FINDINGS

### 2.1 Regional Geology

The site lies within a prominent natural geomorphic province of California, occupying the southwestern quadrant of the state, referred to as the Peninsular Ranges. This province is characterized by steep, elongated ranges and valleys trending northwestward in orientation. More specifically, the site is situated within the northern portion of the Perris Block, a structural block composed of uplifted Cretaceous and older crystalline bedrock. The Perris Block spans an area approximately 20 miles in width by 50 miles in length, bounded by the San Jacinto Fault Zone to the northeast, the Elsinore Fault Zone to the southwest, the Cucamonga Fault Zone to the northwest, and the Temecula Basin to the south.

The basement rock composing the Perris Block were solidified on the order of several thousand feet below their present near surface location, owing to an apparent uplift of similar magnitudes. The uplift is accommodated by relative displacement along the Elsinore and San Jacinto Fault Zones. The region is typically mantled by alluvial/fluvial clastic deposits of Quaternary age, infilling areas between bedrock highs (see Figure 3, *Regional Geology Map*).

The infilling soil units typically consist of alluvial fan deposits derived either from the erosion of nearby bedrock highs, or distal areas of the valley. The valley floor, and subject property, exhibit a gentle southwesterly sloping/descending profile mainly generated by erosion of the geologically elevated “Badlands” region. This region consists of an uplifted range of erodible bedrock along the San Jacinto Fault northeast of the site. The flat-lying valley surface is locally pierced by elevated conical shaped masses of weathered granitic basement rock. One such outcrop occurs just northeast of the subject property, with heights ascending up to approximately 186 feet above the flat-lying surrounding areas.

Moreno valley tends to be transected by various narrow streams entrenched into the fan surface. The stream paths are meandering with the valley plain, except where they encounter areas of hard rock outcrops, where they circumvent around outcrop margins. One such stream defines the northeast site boundary and periodically discharges sediments onto the site as flood deposits.



## 2.2 Site-Specific Geology

Our borings reveal the site is underlain by a thin mantle of tilled topsoil which is not mapped. Underlying this material are sedimentary units interpreted as young and very old Quaternary alluvial fan deposits. The deposits are typically composed of variable lenses of laterally discontinuous silty sands, sandy silts and interlayered poorly-graded sands and lesser fractions of silts and silty clay. Morton et al. (2006) subdivide the on-site alluvial fan deposits into two distinct units as follows:

- Young Alluvial Fan Deposits (Qyf) – (Holocene to late Pleistocene): Based on exposures in our borings and test pits this unit underlies a majority of the property, varying from approximately 15 to 30 feet or greater in thickness. This unit is characterized as a yellow brown to brown silty sand that is loose to medium dense and unconsolidated to moderately consolidated in texture. It is variable in its distribution within the northern area of the site where we infer it as infilling areas of dissected older underlying units. The younger alluvial deposits are expected to possess very low expansion potential ( $EI < 21$ ). Based on our laboratory testing, these materials are expected to exhibit slight to moderate hydro-collapse potential (3 to 9 percent) in the upper 10 to 15 feet bgs.
- Very Old Alluvial Fan Deposits (Qvof) – (middle to late Pleistocene): This unit underlies younger fan deposits to the maximum depth explored (51.5 feet bgs). It varies in depth across the site, encountered near the surface locally in the northern site areas and deeper within southern site areas. The unit consists of reddish brown silty sands to clayey sands with local gravel, which are loose to dense and is unconsolidated to moderately consolidated. Based on our laboratory testing, these deposits also exhibit a slight to moderate hydro-collapse potential (2 to 6 percent) within the upper 10 to 15 feet bgs. The locally increased clay content of this unit suggests it possesses a low expansion potential ( $EI < 51$ ).

Our detailed description of subsurface soil units, and depths to the contacts of these units, are presented within attached Appendix A, *Boring / Test Pit / Infiltration Test Logs*.

## 2.3 Groundwater Conditions

At the time of our exploration, no groundwater was encountered to the maximum depth explored (51.5 feet bgs). According to published groundwater studies encompassing the site area, the depth to groundwater beneath the site in circa 1971 was on the order of 190 feet bgs (USGS, SP 1781). The same publication noted the groundwater table rose to an elevation of around 1,450 feet msl by 2006, corresponding to a depth of approximately 140 feet bgs. Groundwater at this depth

is not anticipated to pose a constraint to proposed site grading. However, fluctuations in the depth of groundwater levels or soil moisture beneath the site, and/or the development of temporary perched water conditions, can occur seasonally as a result of storm events, storm water runoff, stormwater infiltration, or landscape irrigation.

## 2.4 Expansive Soils

As indicated above, the site near surface soils consist of silty sand of low plasticity and expected to possess very low expansion potential (EI<21). The expansion potential of the very old alluvial fan deposits may be higher where containing locally greater concentrations of clay (EI<51).

The inherent variability in alluvial sediment distribution is such that more or less clayey soils may be encountered on the site, in areas beyond the location of our exploration. The presence of disposition of any excessively clayey soils will be evaluated during grading. And conformance testing of as-graded pad surfaces performed to verify design parameters. Although not anticipated, the potential to encounter moderately expansive soils (EI<51) during grading, and inadequately mix or dispose of them such that higher concentrations result at finish pad grade, warranting use of post-tension slab systems, cannot be precluded.

## 2.5 Soil Sulfate Content

Based on our previous experience in the site area, we anticipate a negligible concentration of soluble sulfates in onsite soils. Additional corrosion testing should be performed on representative finish grade soils at the completion of rough grading.

A representative bulk sample of near surface soil collected from a depth between 0 and 5 feet bgs in boring LB-3, was tested to evaluate corrosion potential. Results of chemical analysis tests are attached in Appendix B, *Laboratory Test Results*. A summary of the test results is presented below in Table 1.

**Table 1. Corrosivity Test Results**

Test Parameter	Test Results (LB-3 @ 0-5')	General Classification of Hazard
Water-Soluble Sulfate-SO <sub>4</sub> in Soil (ppm)	140	Negligible sulfate exposure to buried concrete-S0 Exposure Class
Water-Soluble Chloride in Soil (ppm)	20	Non-corrosive to buried concrete (per Caltrans Specifications)
pH	7.40	Mildly alkaline
Minimum Resistivity (saturated ohm-cm)	2900	Moderately corrosive to buried ferrous pipes

## 2.6 Infiltration Testing

Two (2) field percolation tests were performed in the general location of planned bio-retention basin, at planned basin invert depths, within shallow in-situ sandy alluvial soils. The testing was performed in general accordance with the *Riverside County - Low Impact Development BMP Design Handbook (Riverside County Flood Control and Water Conservation District, 2011)*.

Each well was constructed by installing two-inch-diameter PVC casing into the boreholes, screened within test zones and solid above perforated sections. Borehole annular spaces were infilled with clean sand (#3 Monterey Sand) to approximately 1-foot above the screen zone. The wells were then pre-soaked prior to the testing in an attempt to model the behavior of stormwater quality control devices during a design storm event. After the conclusion of the percolation testing, the well casings were removed and the test holes backfilled with native soil tailings.

Based on the results of pre-soaking and initial readings, percolation testing in LP-1 and LP-2 was performed using the falling head test procedure, where the drop of water levels inside the well were recorded over the testing period. Measured percolation rates were calculated by dividing the rate of discharge (cubic inches per hour) by the infiltration surface area, or flow area (square inches). Discharge volume was calculated by adding the total volume of water that dropped within the PVC pipe and annulus incorporating a porosity reduction factor to account for the filter pack material. The flow area was based on the average water height within the slotted pipe section of the test well only.

The results of the percolation testing and resultant measured (un-factored) rates of infiltration obtained from the testing are presented below in Table 2. Detailed test data is presented in Appendix A, *Boring / Test Pit / Infiltration Test Logs*.

**Table 2. Measured Infiltration Rate (Unfactored)**

Percolation Test Boring/Well Designation	Percolation Test Method	Approximate Depth of Test Zone Below Ground Surface (feet)	Unfactored* Infiltration Rate (in/hr)
LP-1	Falling Head	10-13	1.29
LP-2	Falling Head	10-13	0.08

Note: The invert elevation of any stormwater infiltration shall be set back at least 15 feet, and outside a 1:1 plane drawn down and out from the bottom of adjacent foundations.

Measured (un-factored) rates of infiltration indicate that onsite infiltration at the specific location and depth of LP-1 is more favorable than the LP-2 location. The differences in rates as attributable to the deposits encountered within the test zones. The LP-1 test was performed in the young alluvial fan deposits, the LP-2 test was conducted in the very old alluvial fan deposit.

The infiltration rates are the product of small-scale test performed at specific locations and depths. Actual infiltration rates within the area of a proposed infiltration device can vary from that yielded by our testing. Therefore, care must be used in the selection of infiltration rate for use in design and the potential for variances in soil conditions (fines content) that could significantly affect long-term field performance. Infiltration rates can be expected to decline over time between maintenance cycles as BMP surface become occluded and particulates accumulate in the infiltrative layer of testing suggest some lateral variability in both infiltration rates and fines content.

## 3.0 GEOLOGIC AND SEISMIC HAZARD EVALUATION

### 3.1 Faulting

Known surface faults in the region are mapped on Figure 4, *Regional Fault Map*. Our review of available in-house literature indicates the mapped presence of no known active faults on or crossing the site, and the site is not located within a currently-designated Alquist-Priolo Earthquake Fault Zone (CGS, 1999; Bryant and Hart, 2007). A surface fault rupture hazard evaluation is, therefore, not mandated for this site. In addition, no currently known active faults have been mapped within the vicinity of the site having a potential for surface fault rupture. Given an absence of known faults, potential risk for surface fault rupture at this site is low.

### 3.2 Seismicity

Historically, the San Jacinto Fault Complex has produced earthquakes in the magnitude range of 6.0Mw to 7.6Mw (Moment magnitude). In roughly the last 100 years (1903 through 2020), 9 major quakes in the range of 6.0Mw to 7.6Mw have occurred within a 50-mile radius of the subject site. Each of these large quakes has produced moderate to severe damage to buildings and roads, and several have resulted in fatalities (USGS, 1971). The frequency and relatively short recurrence interval of surface rupture for the San Jacinto Fault has resulted in many events during Holocene time with at least 16 documented in the past 3,700 years (Onderdonk et al., 2018).

Common throughout most of Southern California is a potential for strong ground shaking generated by moderate to severe earthquakes. The intensity of ground shaking at a given location depends primarily upon earthquake magnitude, site distance from the source, and site response (soil type) characteristics. Seismic coefficients for the subject site were calculated utilizing an interactive program on current United States Geological Survey (USGS) website using ASCE 7-16 procedures. Based on the results of seismic profiling, the soil sediments underlying the site are classified as Site Class D. As such, the site-specific seismic coefficients are as presented below in Table 3. Copies of seismic analysis data are attached in Appendix C, *Seismic Design Data and Settlement Analyses*.

**Table 3. 2019 CBC-Based Seismic Design Parameters**

Categorization/Coefficient	Design Value
Site Latitude: 33.9205, Site Longitude: -117.1871	
Site Class: D	
Mapped Spectral Response Acceleration at Short Period (0.2 sec), $S_s$	1.92g
Mapped Spectral Response Acceleration at Long Period (1 sec), $S_1$	0.76g
Short Period (0.2 sec) Site Coefficient, $F_a$	1.0
Long Period (1 sec) Site Coefficient, $F_v$	1.7 <sup>1</sup>
Adjusted Spectral Response Acceleration at Short Period (0.2 sec), $S_{MS}$	1.92g
Adjusted Spectral Response Acceleration at Long Period (1 sec), $S_{M1}$	1.29g <sup>1</sup>
Design Spectral Response Acceleration at Short Period (0.2 sec), $S_{DS}$	1.28g
Design Spectral Response Acceleration at Long Period (1 sec), $S_{D1}$	0.86g <sup>1</sup>
PGA adjusted for Site Class, $PGA_M = F_{PGA} * PGA$	0.89g
g = Gravity acceleration <sup>1</sup> Per Exception 2 in Section 11.4.8 of ASCE 7-16, seismic response coefficient $C_S$ to be determined by Eq. 12.8-2 for values of $T < 1.5T_s$ and taken as equal to 1.5 times the value computed in accordance with either Eq. 12.8-3 for $TL > T > 1.5T_s$ or Eq. 12.8-4 for $T > TL$	

The project structural engineer should confirm if the above applies for the proposed structures, else a site-specific ground motion analysis may be required.

### 3.3 Other Geologic Hazards

Other site geologic hazards associated with this site are discussed in subsections below.

#### 3.3.1 Liquefaction Potential

According to the Liquefaction Map published on the ESRI ArcGIS website the site is defined as having a low liquefaction susceptibility, see Figure 5, *Liquefaction Map*. This regional scale mapping represents only a general distribution of the liquefaction potential, and not a definitive indication that liquefaction can or will occur. It is intended to inform practitioners of its potential so that appropriate hazard analyses may be incorporated into a development project. The southern areas of the site correspond to mapped areas of Quaternary Young Alluvial Fan deposits. This unit is defined as having a moderate susceptibility to liquefaction. These younger alluvial fan deposits are underlain by Pleistocene age very old fan deposits that are generally not susceptible to liquefaction. Given an absence of groundwater encountered beneath the site at or above a depth of 50 feet bgs, the potential constraint to the proposed development due to liquefaction and related seismic-induced settlement is considered very low.

### 3.3.2 Seismically-Induced Settlement

During a strong seismic event, and in the absence of groundwater, seismically-induced settlement can still occur within loose to medium dense and dry or moist granular soils. Settlement caused by ground shaking is often non-uniformly distributed, which can result in differential settlement. Based on the design earthquake and a Peak Ground Acceleration (PGA) of 0.89g, the magnitude of dynamic dry settlement is estimated to be on the order of approximately 4.0 inches (see Appendix C), assuming remedial grading is performed in compliance with Section 5.1 of this report. Given the similar lithology of the onsite soil units and implementation of proposed remedial grading, anticipated dynamic settlement is expected to occur over a widespread area of the site. As such, the differential settlement is not expected to exceed 1-inch in a 30-foot horizontal distance.

### 3.3.3 Lateral Spreading

As the potential for liquefaction is expected to be very low, and the property is well constrained laterally, the potential for earthquake-induced lateral spreading at the site is considered negligible.

### 3.3.4 Slope Stability and Seismically Induced Landslides

The site is relatively flat in topographic relief and not designated on County of Riverside hazard maps as occurring within a landslide hazard zone. No slopes or other elevated areas of any significance exist on or adjacent to the property which could be potential source of landslides. Based on the above, the potential for slope instability or seismically induced landslides is considered negligible.

## 3.4 **Earthquake-Induced Flooding**

The potential for earthquake-induced flooding can relate to the failure of nearby dams or other water-retaining structures as a result of earthquakes. There are no nearby water retaining structures and the site is not located within a mapped Dam Inundation Risk zone. The potential for earthquake induced flooding to affect this site is considered negligible.

## 3.5 **Flooding**

Federal Emergency Management Agency (FEMA) flood insurance rate map Nos. 06065C0770G and 06065C0765G (FEMA, 2008), indicate the project site is located within Zone X, designated as “an area of minimal flood hazard.” As shown on Figure 6, *Flood Hazard Zone Map*, the site is **not** located within a flood hazard zone.

### 3.6 Land Subsidence

Land subsidence refers to the sinking or gradual downward settlement and compaction of soil deposits, commonly associated with the extraction of deep groundwater and/or petroleum resources from a region. Subsidence can be manifest at the surface by a broad lowering of topography in the form of depression(s), often recognized within sedimentary basins by the formation of arcuate tension cracking along basin margins, with little or no lateral movement. According to the County of Riverside, the site is mapped within a zone susceptible to subsidence, based only on the presence of geologic and/or hydrogeologic conditions similar to areas having experienced such hazards in the past. The mapped limits of this zone are shown on attached Figure 7, *Subsidence Map*. Given the site is not situated near any active faults or basin margin, the effects of any potential subsidence on the development is considered to be low.



## 4.0 SUMMARY OF FINDINGS AND CONCLUSIONS

A summary of our geologic and geotechnical findings and conclusions are presented below:

- The relatively loose near surface alluvial soils possess relatively significant degree of potential collapse (up to 9 percent). As such, over-excavation and recompaction to depths varying from 7 to 14 feet will be required to reduce potential differential settlement to tolerable limits. More specific grading recommendations are provided in Section 5.1.2 below.
- Groundwater was not encountered within the maximum depth of our exploration (51.5 feet bgs). Regional literature indicates groundwater occurs at depths of at least 140 feet bgs. Given the above, groundwater is expected to pose no constraint to site development.
- Results of shallow field percolation testing within the proposed central bio-retention basin, at the invert depth tested, is considered feasible for use as a part of on-site stormwater system design.
- Results of shallow field percolation testing within the bio-retention basin planned near the southern site margin is not considered suitable for infiltration at the invert depth tested.
- The site is not located within an Alquist-Priolo Earthquake Fault Zone, nor was any evidence of active faulting observed on or as projection towards the site. Surface fault rupture is not considered a site hazard.
- The close proximity of major faults and historical earthquakes indicate occurrence of strong ground shaking at the site is likely during its economic life-span.
- Deposits of young alluvial fan material are expected to possess a very low expansion potential (EI<21), and, very old alluvial fan materials are expected to possess a low expansion (EI<51).
- The potential exists to encounter very old alluvial sediments with locally higher clay concentrations.
- Materials generated by both the younger and very old geologic units on the site are expected to be suitable for use as compacted fill, provided it is relatively free of organic material and debris.
- The site soil units can be readily excavated, processed and compacted using a conventional grading equipment in good repair.
- Finish building pads, slope faces and other graded surfaces will be susceptible to erosion if left unprotected. This risk can be reduced through installation of certain control measures including but not limited to a jute net cover, erosion control blankets, straw wattles, or other similar methods of protection.
- Caving and raveling of soils in un-shored excavations should be expected.

## 5.0 RECOMMENDATIONS

The following geotechnical recommendations are provided for project site grading and construction.

### 5.1 General Earthwork Considerations

All site grading should be performed in accordance with applicable local regulatory codes, and project specifications prepared by applicable design professional. Detailed grading recommendations are attached herein as Appendix D, *General Earthwork and Grading Specifications for Rough Grading*.

#### 5.1.1 Site Preparation

Prior to construction, the site should be cleared of any vegetation, trash, and/or debris within the area of proposed grading. These materials should be removed from the site. Any underground obstructions onsite should be removed. Existing utility lines will need to be removed and/or rerouted where interfering with the proposed construction. Any resulting excavation cavities should be properly backfilled and compacted. All unsuitable earth deposits should be excavated and removed from the footprints of proposed buildings/structures prior to fill placement. Any existing undocumented fill will need to be removed from areas of planned structural improvements.

#### 5.1.2 Remedial Grading

The upper 7 to 9 feet of existing surficial soil in the northern portion of the site (north of projected Bay Avenue) should be removed/over-excavated and recompacted prior to foundation construction or placement of any additional fill. Similarly, the upper 12 to 14 feet of existing surficial soil in the southern portion of the site (south of Bay Avenue) should be removed/over-excavated and recompacted. The removal limits should be established via 1:1 (horizontal: vertical) projection from the edges of structural fills (soils supporting settlement-sensitive structures) downward and outward to competent material identified by the geotechnical consultant. Removal will also include benching into competent material as the fills rise. Areas adjacent to existing structures/roadways or property limits may require special considerations and monitoring. Deeper removals may be required in local areas based on prevailing soils conditions.

#### 5.1.3 Fill Placement and Compaction

Fill soils should be placed in loose lifts not exceeding 8 inches, moisture-conditioned to within 2 percent of optimum moisture content for sandy soils and at least 4 percent above optimum moisture content for clayey soils (not

anticipated), and compacted to a minimum of 90 percent of the maximum dry density as determined by ASTM Test Method D 1557.

#### 5.1.4 Shrinkage and Subsidence

The volume change of excavated onsite materials upon compaction is expected to vary with materials, volume of roots and deleterious materials, density, insitu moisture content, location, and compaction effort. The in-place and compacted densities of soil materials vary and accurate overall determination of shrinkage and bulking cannot be made. Therefore, we recommend site grading include, if possible, a balance area or ability to adjust import quantities to accommodate some variation. Based on our experience with similar materials, we anticipate 10 to 18 percent shrinkage in the upper 10 to 15 feet of alluvium. Subsidence due solely to scarification, moisture conditioning and recompaction of the exposed bottom of overexcavation, is expected to be on the order of 0.15 foot. This should be added to the above shrinkage value calculations for the recompacted fill zone.

#### 5.1.5 Import Soils

Import soils and/or borrow sites, if needed, should be evaluated by the geotechnical consultant prior to import. Import soils should be uncontaminated, granular in nature, free of organic material (loss on ignition less-than 2 percent), have a very low expansion potential (with an Expansion Index less than 12) and have a low corrosion impact to the proposed improvements.

#### 5.1.6 Utility Trenches

Utility trenches should be backfilled with compacted fill in accordance with Sections 306-1.2 and 306-1.3 of the Standard Specifications for Public Works Construction, ("Greenbook"), 2021 Edition (or most recent). Fill material above the pipe zone should be placed in lifts not exceeding 8 inches in uncompacted thickness and should be compacted to at least 90 percent relative compaction (ASTM D 1557) by mechanical means only. Site soils may generally be suitable as trench backfill provided these soils are screened of rocks over 1½ inches in diameter and organic matter. If imported sand is used as backfill, the upper 3 feet in building and pavement areas should be compacted to 95 percent. The upper 6 inches of backfill in all pavement areas should be compacted to at least 95 percent relative compaction.

Where granular backfill is used in utility trenches adjacent moisture sensitive subgrades and foundation soils, we recommend that a cut-off "plug" of impermeable material be placed in these trenches at the perimeter of buildings, and at pavement edges adjacent to irrigated landscaped areas. A "plug" can consist of a 5-foot long section of clayey soils with more than 35-percent passing the No. 200 sieve, or a Controlled Low Strength Material

(CLSM) consisting of one sack of Portland-cement plus one sack of bentonite per cubic-yard of sand. CLSM should generally conform to Section 201-6 of the "Greenbook". This is intended to reduce the likelihood of water permeating trenches from landscaped areas, then seeping along permeable trench backfill into the building and pavement subgrades, resulting in wetting of moisture sensitive subgrade earth materials under buildings and pavements.

Excavation of utility trenches should be performed in accordance with the project plans, specifications and the California Construction Safety Orders (current Edition). The contractor should be responsible for providing a "competent person" as defined in Article 6 of the California Construction Safety Orders. Contractors should be advised that sandy soils (such as fills generated from the onsite alluvium) could make excavations particularly unsafe if all safety precautions are not properly implemented. In addition, excavations at or near the toe of slopes and/or parallel to slopes may be highly unstable due to the increased driving force and load on the trench wall. Spoil piles from the excavation(s) and construction equipment should be kept away from the sides of the trenches. Leighton does not consult in the area of safety engineering.

#### 5.1.7 Drainage

All drainage should be directed away from structures, slopes and pavements by means of approved permanent/temporary drainage devices. Adequate storm drainage of any proposed pad should be provided to avoid wetting of foundation soils. Irrigation adjacent to buildings should be avoided when possible. As an option, sealed-bottom planter boxes and/or drought resistant vegetation should be used within 5-feet of buildings.

#### 5.1.8 Slope Design and Construction

Based on our understanding and for planning purposes, all fill and cut slopes will be designed and constructed at 2:1 (horizontal:vertical) and expected to be less than 10 feet in height. These slopes are considered grossly stable for static and pseudostatic conditions. For planning purposes, cut slopes should be constructed as replacement fill slopes due to the highly erosive nature of site soils. Future grading plans should be subject to further review and evaluation.

The outer portion of fill slopes should be either overbuilt by 2 feet (minimum) and trimmed back to the finished slope configuration or compacted in vertical increments of 5 feet (maximum) by a weighted sheepsfoot roller as the fill is placed. The slope face should then be track-walked by dozers of appropriate weight to achieve the final slope configuration and compaction to the slope face.

Slope faces are inherently subject to erosion, particularly if exposed to wind, rainfall and irrigation. Landscaping and slope maintenance should be conducted as soon as possible in order to increase long-term surficial stability. Berms should be provided at the top of fill slopes. Drainage should be directed such that surface runoff on the slope face is minimized.

## 5.2 Foundation Design

Based on our analysis, and upon implementation of remedial grading measures recommendations herein, the use of shallow isolated and/or continuous footings will be suitable to support the proposed residential structures.

### 5.2.1 Bearing and Lateral Pressures

The proposed foundations and slabs should be designed in accordance with the structural consultants' design, the minimum recommendations presented herein, and the 2019 CBC. In utilizing the minimum geotechnical foundation recommendations, the structural consultant should design the foundation system to acceptable deflection criteria as determined by the architect. Foundation footings may be designed with the following geotechnical design parameters:

- **Bearing Capacity:** A net allowable bearing capacity of 2,500 pounds per square foot (psf), or a modulus of subgrade reaction of 200 pci may be used for design of footings founded entirely into compacted fill. The footings should extend a minimum of 12 inches below lowest adjacent grade. A minimum base width of 18 inches for continuous footings and a minimum bearing area of 3 square feet (1.75 ft by 1.75 ft) for pad foundations should be used. Additionally, an increase of one-third may be applied when considering short-term live loads (e.g. seismic and wind).
- **Passive Pressures:** The passive earth pressure may be computed as an equivalent fluid having a density of 300 psf per foot of depth, to a maximum earth pressure of 3,000 pounds per square foot. A coefficient of friction between soil and concrete of 0.35 may be used with dead load forces. When combining passive pressure and frictional resistance, the passive pressure component should be reduced by one-third

The footing width, depth, reinforcement, slab reinforcement, and the slab-on-grade thickness should be designed by the project structural consultant based on recommendations and soil characteristics indicated herein and the most recently adopted edition of the CBC.

### 5.2.2 Settlement

The project civil engineer, structural engineer, and architect should consider the potential effects of both static settlement and dynamic settlement presented below.

- **Static Settlement:** Most of the static settlement of onsite soils is expected to be immediate or within 30 days following fill placement/foundations. A differential static settlement of 0.5 inch over a 30-foot span may be considered for design purposes.
- **Dynamic Settlement:** Based on our analysis, we estimate total dynamic settlement is expected to be approximately 4 inches. Due to relatively uniform alluvium conditions, this settlement is expected to be global and differential settlement minimal or less than 1-inch over a 30-foot horizontal span.

### 5.2.3 Vapor Retarder

It has been a standard of care to install a moisture retarder underneath all slabs where moisture condensation is undesirable. Moisture vapor retarders may retard but not totally eliminate moisture vapor movement from the underlying soils up through the slabs. Moisture vapor transmission may be additionally reduced by use of concrete additives. Leighton does not practice in the field of moisture vapor transmission evaluation/mitigation. Therefore, we recommend that a qualified person/firm be engaged/consulted to evaluate the general and specific moisture vapor transmission pathways and any impacts to proposed construction elements. This person/firm should provide recommendations for mitigation of potential adverse impact of moisture vapor transmission on various components of the structure as deemed appropriate.

However, based on our experience, the standard of practice in Southern California has evolved over the last 15 to 20 years where an acceptable vapor retarder system includes a membrane (such as 10-mil thick or greater), underlain by a capillary break consisting of 4 inches of clean ½-inch-minimum gravel or 2-inch sand layer (SE>30). The structural engineer/architect or concrete contractor often require a sand layer be placed over the membrane (typically 2-inch thick layer) to help in curing and reduction of curling of concrete. If such sand layer is placed on top of the membrane, the contractor should not allow the sand to become wet prior to concrete placement (e.g., sand should not be placed if rain is expected).

In conclusion, construction of the vapor barrier/retarder system is dependent on several variables which cannot all be evaluated and/or tested from a geotechnical standpoint. As such, the design of this system should be a design team/owner decision taking into consideration finish flooring materials and manufacture's installation requirements of proposed membrane.

Moreover, we recommend that the design team also follow ACI Committee 302 publication for “Guide for Concrete Slabs that Receive Moisture-Sensitive Flooring Materials” (ACI 302.2R-06) which includes a flow chart that assists in determining if a vapor barrier /retarder is required and where it is to be placed.

### 5.3 Temporary Excavation and Shoring Design

All temporary excavations for utility trenches, retaining walls, and foundations should be performed in accordance with project plans, specifications, and all OSHA requirements. Excavations 5 feet or deeper should be laid back or shored in accordance with OSHA requirements before personnel are allowed to enter. Site soils should be considered as Type C Soil per OSHA guidelines.

No surcharge loads should be permitted within a horizontal distance equal to the height of cut or 5 feet, whichever is greater from the top of the cut, unless the cut is shored appropriately. Excavations that extend below an imaginary plane inclined at 45 degrees below the edge of any adjacent existing site foundation should be properly shored to maintain support of the adjacent structure.

### 5.4 Preliminary Pavement Design Parameters

Our laboratory testing of a bulk soil sample collected from a depth of 0 to 5 feet bgs, yielded an R-value of 25. Pavement section recommendations based on this test are presented below in Table 4. The recommendations are intended for planning purposes only and should not supersede minimum City or County requirements. For final pavement design, appropriate traffic indices should be selected by the project civil engineer or traffic engineering consultant. Additional testing should be performed to verify design parameters once samples representative of finish soil subgrade material are confirmed and collectible.

**Table 4. Pavement Section Design**

Street Type	Loading Conditions TI	AC Pavement Section Thickness	
		Asphaltic-Concrete (AC) Thickness (inch)	Aggregate Base (AB) Thickness (inch)
Alleys/Local Streets	5	3.0	6.0
Collector Street/ Truck Access	6	3.5	8.5
Perimeter Roadways	7	4.0	10.5

The upper 6 inches of subgrade soil should be properly compacted to at least 95 percent relative compaction (ASTM D1557) and should be moisture-conditioned to near optimum and kept in this condition until the pavement section is constructed. Proof-rolling subgrade to identify localized areas of yielding subgrade (if any) should be performed prior to placement of aggregate base and under the observation of the geotechnical consultant.

Minimum relative compaction requirements for aggregate base should be 95 percent of the maximum laboratory density as determined by ASTM D1557. Base rock should conform to the "Standard Specifications for Public Works Construction" (green book) current edition or Caltrans Class 2 aggregate base having a minimum R-value of 78. Asphaltic concrete should be placed on compacted aggregate base and compacted to minimum 95% relative compaction.

The pavement sections provided in this section are intended as minimum values. Should thinner or highly variable as-built pavement sections result from construction, increased maintenance and repair may be needed.

## 5.5 Retaining Walls

Retaining wall earth pressures are a function of the amount of wall yielding horizontally under load. If a wall can yield enough to mobilize full shear strength of backfill soils, then it can be designed for "active" pressure. If a wall cannot yield under the applied load, the shear strength of the soil cannot be mobilized and the earth pressure will be higher. Such walls should be designed for "at rest" conditions. If a structure moves toward the soils, the resulting resistance developed by the soil is the "passive" resistance. Retaining walls backfilled with non-expansive soils should be designed using the following equivalent fluid pressures:

**Table 5. Retaining Wall Design Earth Pressures (Static, Drained)**

Loading Conditions	Equivalent Fluid Density (pcf)	
	Level Backfill	2:1 Backfill
Active	33	50
At-Rest	50	80
Passive*	300	150 (2:1, sloping down)

\*This assumes level condition in front of the wall will remain for the duration of the project, not to exceed 3,000 psf at depth. If sloping down (2:1) grades exist in front of walls, then they should be designed using passive values reduced to ½ of level backfill passive resistance values.



Unrestrained (yielding) cantilever walls should be designed for the active equivalent-fluid weight value provided above for very low to low expansive soils that are free draining. In the design of walls restrained from movement at the top (non-yielding) such as basement or elevator pit/utility vaults, the at-rest equivalent fluid weight value should be used. Total depth of retained earth for design of cantilever walls should be measured as the vertical distance below the ground surface measured at the wall face for stem design, or measured at the heel of the footing for overturning and sliding calculations. Should a sloping backfill other than a 2:1 (horizontal:vertical) be constructed above the wall (or a backfill is loaded by an adjacent surcharge load), the equivalent fluid weight values provided above should be re-evaluated on an individual case basis by us. Non-standard wall designs should also be reviewed by us prior to construction to check that the proper soil parameters have been incorporated into the wall design.

All retaining walls should be provided with appropriate drainage. The outlet pipe should be sloped to drain to a suitable outlet. Typical wall drainage design is illustrated in Appendix E, *Retaining Wall Backfill and Subdrain Detail*. Wall backfill should be non-expansive ( $EI \leq 21$ ) sands compacted by mechanical methods to a minimum of 90 percent relative compaction (ASTM D 1557). Clayey site soils should not be used as wall backfill. Walls should not be backfilled until wall concrete attains the 28-day compressive strength and/or as determined by the Structural Engineer that the wall is structurally capable of supporting backfill. Lightweight compaction equipment should be used, unless otherwise approved by the Structural Engineer.

## 5.6 Foundation Setback from Slopes

We recommend a minimum horizontal setback distance from the face of slopes for all structural footings (retaining and decorative walls, flatwork, building footings, pools, etc.). This distance is measured from the outside bottom edge of the footing horizontally to the slope face (or the face of a retaining wall) and should be a minimum of  $H/2$ , where H is the slope height (in feet).

**Table 6. Footing Setbacks**

Slope Height	Recommended Footing Setback
<5 feet	5 feet minimum
5 to 15 feet	7 feet minimum
>15 feet	$H/2$ , where H is the slope height, not to exceed 10 feet to 2:1 slope face

\*Per county minimum or as calculated

The soils within the structural setback area generally possess poor lateral stability and improvements (such as retaining walls, pools, sidewalks, fences, pavements, decorative flatwork, etc.) constructed within this setback area will be subject to lateral movement and/or differential settlement. Potential distress to such improvements may be mitigated by providing a deepened footing or a pier and grade-beam foundation system to support the improvement. The deepened footing should meet the setback described above. Modifications of slope inclinations near foundations may increase the setback and should be reviewed by the design team prior to completion of design or implementation.

## 5.7 Concrete Flatwork

Exterior concrete slabs-on-grade should have a minimum thickness of 4 inches. Common Type II cement should be adequate for concrete flatwork not exposed to recycled water. Type V cement and a water:cement ratio of 0.45 should be used for concrete exposed to recycled water.

Concrete flatwork should be placed on compacted fill. If this material has been disturbed or become dry or desiccated, the subgrade soil should be moisture conditioned to near optimum moisture content and recompacted to a minimum of 90 percent relative compaction to a depth of 12 inches. Moisture content should be checked 48 hours prior to placing concrete.

As discussed in conjunction with floor slabs, minor cracking of concrete after curing due to expansion, drying and shrinkage is normal and should be expected. However, cracking is often aggravated by a high water-to-cement ratio, high concrete temperature at the time of placement, small nominal aggregate size, and rapid moisture loss due to hot, dry, and/or windy weather conditions during placement and curing. Cracking due to temperature and moisture fluctuations can also be expected.

The use of low-slump concrete or low water/cement ratios can reduce the potential for shrinkage cracking. Inclusion of joints at frequent intervals and reinforcement will help control the locations of cracking, and improve aesthetics. Control joints should be spaced at regular intervals no greater than 6 feet on-center and have appropriate joints and saw cuts in accordance with either Portland Cement Association (PCA) or American Concrete Institute (ACI) guidelines. If cracking occurs, repairs may be needed to mitigate a trip hazard (should it develop) and/or improve the appearance.

*Landscape areas must be separated from pavements with concrete curbs and/or edge drains. Excessive over-irrigation will have an adverse effect on adjacent pavements. Irrigation adjacent to pavements, without a deep curb or other cutoff to separate landscaping from paving will result in premature pavement distress.*

## 6.0 GEOTECHNICAL CONSTRUCTION SERVICES

The long term integrity and performance of foundation and earthwork improvements for residential development projects is closely attributable to an adequate construction review process. Geotechnical review is of paramount importance as a part of this process. To verify that project grading and foundation plans conform to the recommendations of this report, we recommend Leighton professionals be retained to review these plan(s) once available.

Direct observation and testing by the geotechnical professional during remedial grading and foundation construction allows for an assessment of exposed soil conditions and verification of the geotechnical conclusions and recommendations presented herein. Our presence also affords opportunity to provide alternative recommendations where/if warranted to address unanticipated conditions in the field. We therefore recommend that Leighton be retained during rough and precise grading earthwork to provide these services. Our geotechnical observation and testing services are typically required by the city for the following:

- Following completion of site demolition and clearing;
- During ground preparation, subsurface excavation, and overexcavation of soils;
- During compaction of all fill materials;
- Following foundation excavation, prior to placement of any forms, steel or concrete;
- During slab-on-grade, driveway and flatwork subgrade preparation,
- During street, curb-gutter base placement and asphalt paving;
- During utility trench backfilling and compaction; and
- When any unusual conditions are encountered.

## 7.0 LIMITATIONS

Leighton and Associates, Inc.'s work was performed using the degree of care and skill ordinarily exercised, under similar circumstances, by reputable geotechnical consultants practicing in California at this time. No other warranty, express or implied, is made as to the conclusions and professional opinions included in this report.

This report is issued with the understanding that it is the responsibility of the owner or a duly authorized agent acting on behalf of the owner, to ensure that information and recommendations contained herein are brought to the attention of the necessary design consultants for this project and incorporated into plans and specifications.

The conclusions and preliminary recommendations in this report are based in part upon data that were obtained from a necessarily limited number of observations, site visits, excavations, samples and tests. Such information can be obtained only with respect to the specific locations explored, and therefore may not completely define all subsurface conditions throughout the site. The nature of many sites is that differing geotechnical and/or geological conditions can occur within small distances and under varying climatic conditions. Furthermore, changes in subsurface conditions can and do occur over time. Therefore, the findings, conclusions, and recommendations presented in this report should be considered preliminary if unanticipated conditions are encountered and additional explorations, testing and analyses may be necessary to develop alternative recommendations.

Any persons using this report for bidding or construction purposes should perform such independent investigations as they deem necessary to satisfy themselves as to the surface and/or subsurface conditions to be encountered and the procedures to be used in the performance of work on the subject site. For additional information about geotechnical engineering studies and this reports and its applicability, provided by the Geoprofessional Business Association (GBA), the client is referred to Appendix F, *GBA Important Information About This Geotechnical Engineering Report*.

## 8.0 REFERENCES

- Bean, Robert T., and others, 1959, Geology of San Jacinto and Elsinore Units, Appendix B, in Santa Ana River Investigations: California Department.
- Bryant, W.A., and Hart, E.W., 2007, Fault-Rupture Hazard Zones in California, Alquist-Priolo Earthquake Fault Zoning Act with Index to Earthquake Zones Maps, Department of Conservation, California Geological Survey, Special Publication 42. 2007 Interim Revision.
- California Building Code, (CBC) 2019, California Code of Regulations Title 24, Part 2, Volume 2 of 2.
- California State Water Resources Control Board, 2016, GEOTRACKER, website: <http://geotracker.waterboards.ca.gov/>
- California, State of, Department of Conservation, Division of Mines and Geology (now CGS), 1994, Subsidence and Ground Fissures in the San Jacinto Basin Area, Southern California, Open-File Report, 94-532.
- Campbell, Kenneth, W., 1996, Strong Motion Attenuation Relationships, in Seismic Hazards Analysis, AEG Short Course, Thomas F. Blake Program Coordinator, January 20, 1996.
- Hutton, L. K., L. M. Jones, E. Hauksson, and D. D. Given, 1991, Seismotectonics of Southern California, in Neotectonics of North America, D. B. Slemmons, E. R. Engdahl, M. D. Zoback, and D. D. Blackwell (Editors), Geol. Soc. Am., Decade Map, Voll, Boulder, Colorado.
- Lofgren, Ben E., and Rubin, Meyer, 1976, Land subsidence and aquifer-system compactions in the San Jacinto Valley, Riverside County, California—progress report: Journal Research vs. Geological Survey, Vol. 4 No 1.
- Morton, D.M., 1977, Surface Deformation in Part of the San Jacinto Valley, Southern California, in Journal of Research, U.S.G.S., Vol 5, No. 1.
- \_\_\_\_\_, 2008, National Seismic Hazard Maps – Fault Parameters, [http://geohazards.usgs.gov/cfusion/hazfaults\\_2008\\_search/query\\_main.cfm](http://geohazards.usgs.gov/cfusion/hazfaults_2008_search/query_main.cfm).
- OSHPD, 2022, Seismic Design Maps, an interactive computer program on OSHPD website to calculate Seismic Response and Design Parameters based on ASCE 7-16 seismic procedures, <https://seismicmaps.org/>
- Onderdonk, N., et.al, 2018, A 3,700 yr. paleoseismic record from northern San Jacinto fault and implications for joint rupture of the San Jacinto and San Andreas faults, dated October 2018, Geosphere.

Public Works Standard, Inc., 2021, Greenbook, *Standard Specifications for Public Works Construction*: BNI Building News, Anaheim, California.

Riverside County, 2019, Safety Element, dated August 6.

Thatcher, W., and T. Hanks, 1973, Source parameters of Southern California Earthquakes, *J. Geophysics. Res.*78, 8547–8576.

United States Geological Survey, (USGS) Pasadena Office, California Earthquake History, 1769 to Present: [www.pasadena.wr.usgs.gov/info/cahist\\_eqs.html](http://www.pasadena.wr.usgs.gov/info/cahist_eqs.html).

\_\_\_\_\_, 1971, Editors Jerry L. Coffman and Carl A von Hake, Earthquake History of the United States, in USGS Publication 41-1.

\_\_\_\_\_, 2005, Preliminary Geologic Map of the Hemet 7.5' Quadrangle, Riverside County, California, Version 1.1, USGS OFR-2004-1455.

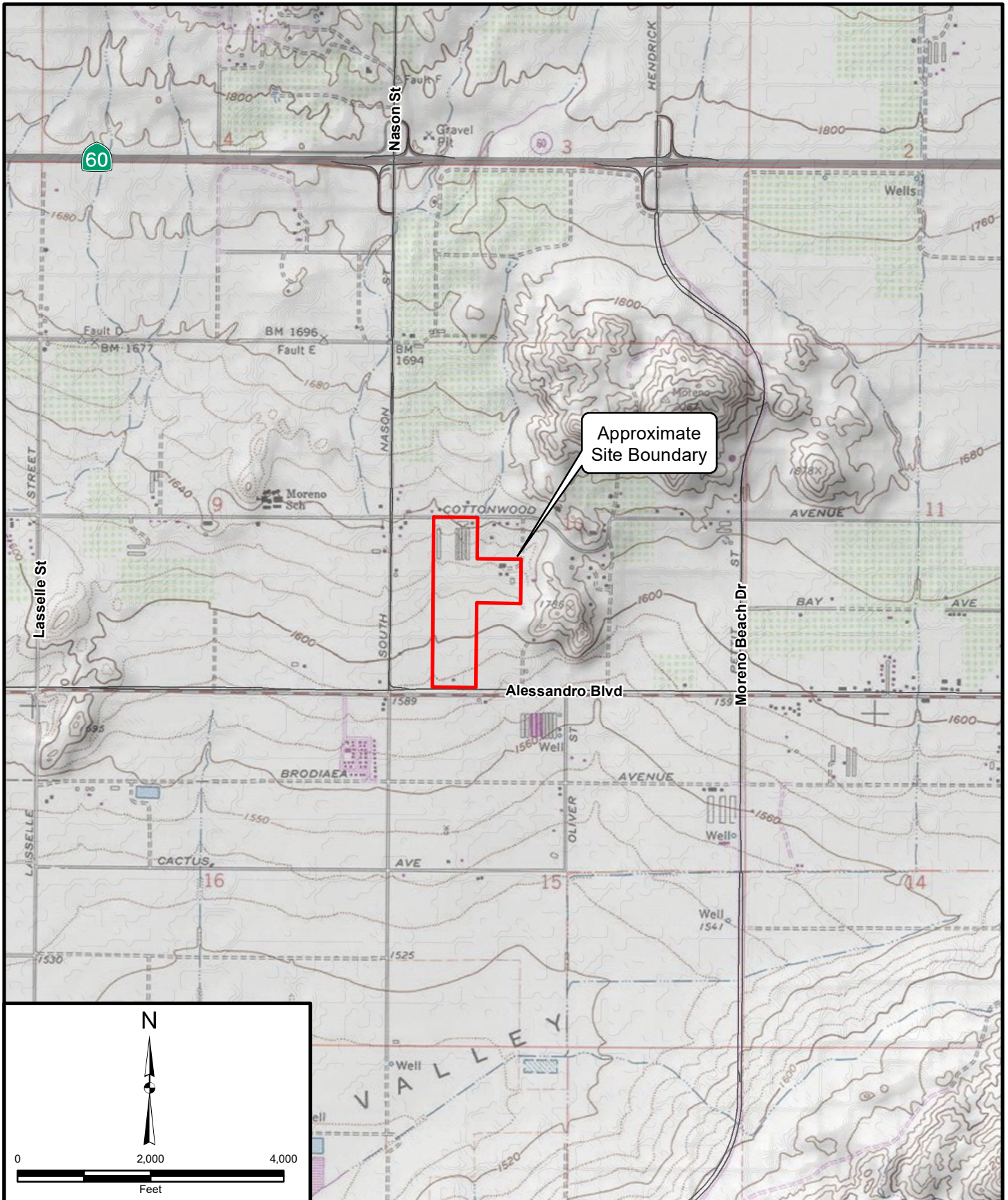

Project: 13169.003	Eng/Geol: JLH/SIS
Scale: 1" = 2,000'	Date: March 2022
Reference: Copyright:© 2013 National Geographic Society, i-cubed	

**SITE LOCATION MAP**  
 50-Acre Residential Development Project  
 City of Moreno Valley  
 Riverside County, California

**FIGURE 1**





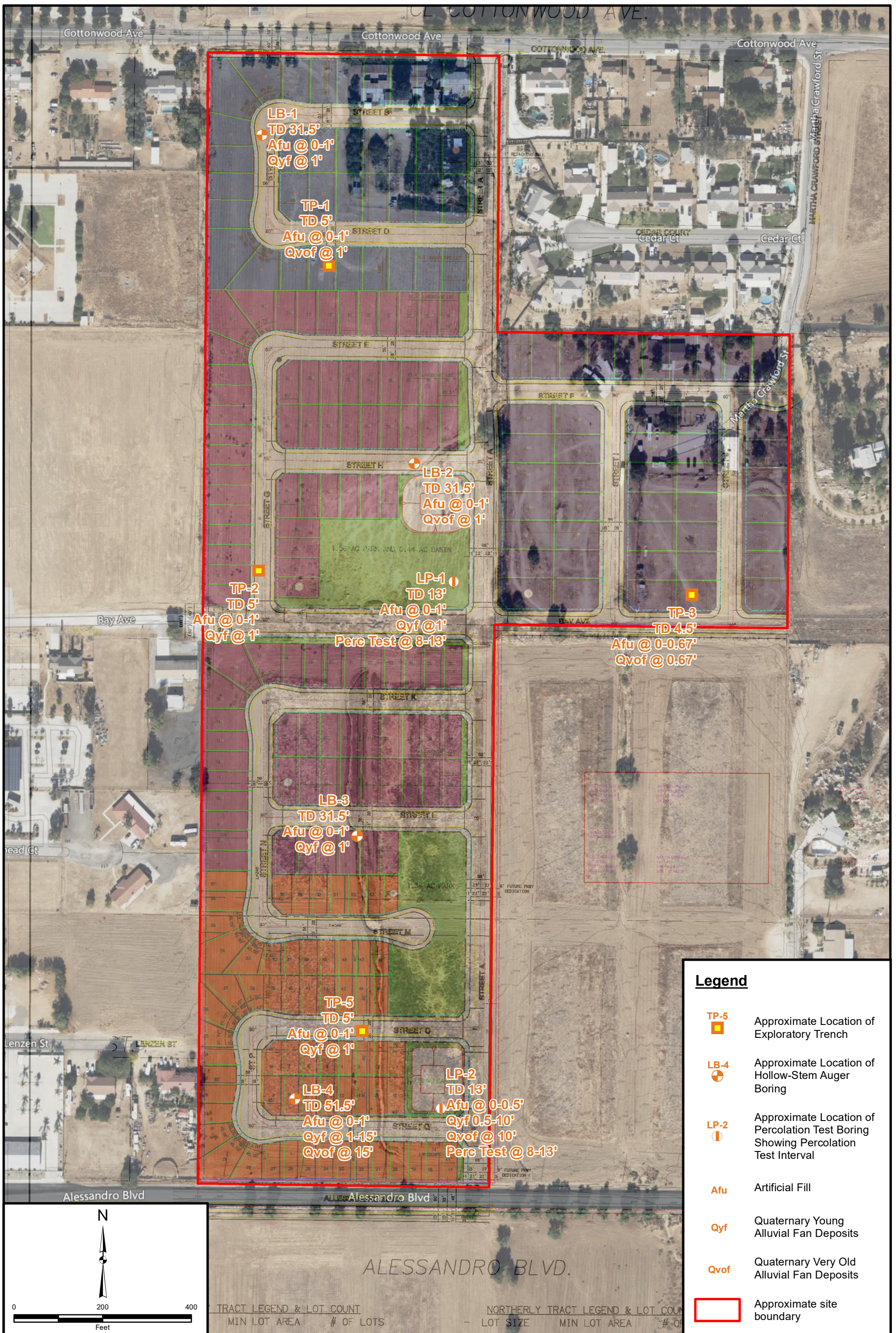

**Legend**





- TP-5 Approximate Location of Exploratory Trench
- ⊕ LB-4 Approximate Location of Hollow-Stem Auger Boring
- ⊕ LP-2 Approximate Location of Percolation Test Boring Showing Percolation Test Interval
- Afu Artificial Fill
- Qyf Quaternary Young Alluvial Fan Deposits
- Qvof Quaternary Very Old Alluvial Fan Deposits
- Approximate site boundary

Project: 13169.003 Eng/Geol: JLH/SIS  
 Scale: 1" = 200' Date: May 2022  
 Reference: © 2022 Microsoft Corporation © 2022 Maxar ©CNES (2022) Distribution Airbus DS © 2022 TomTom

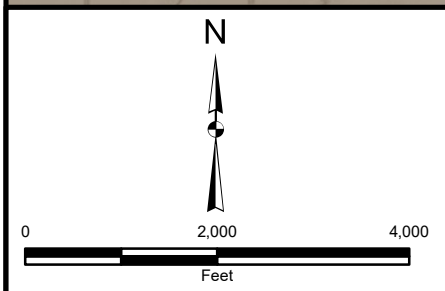
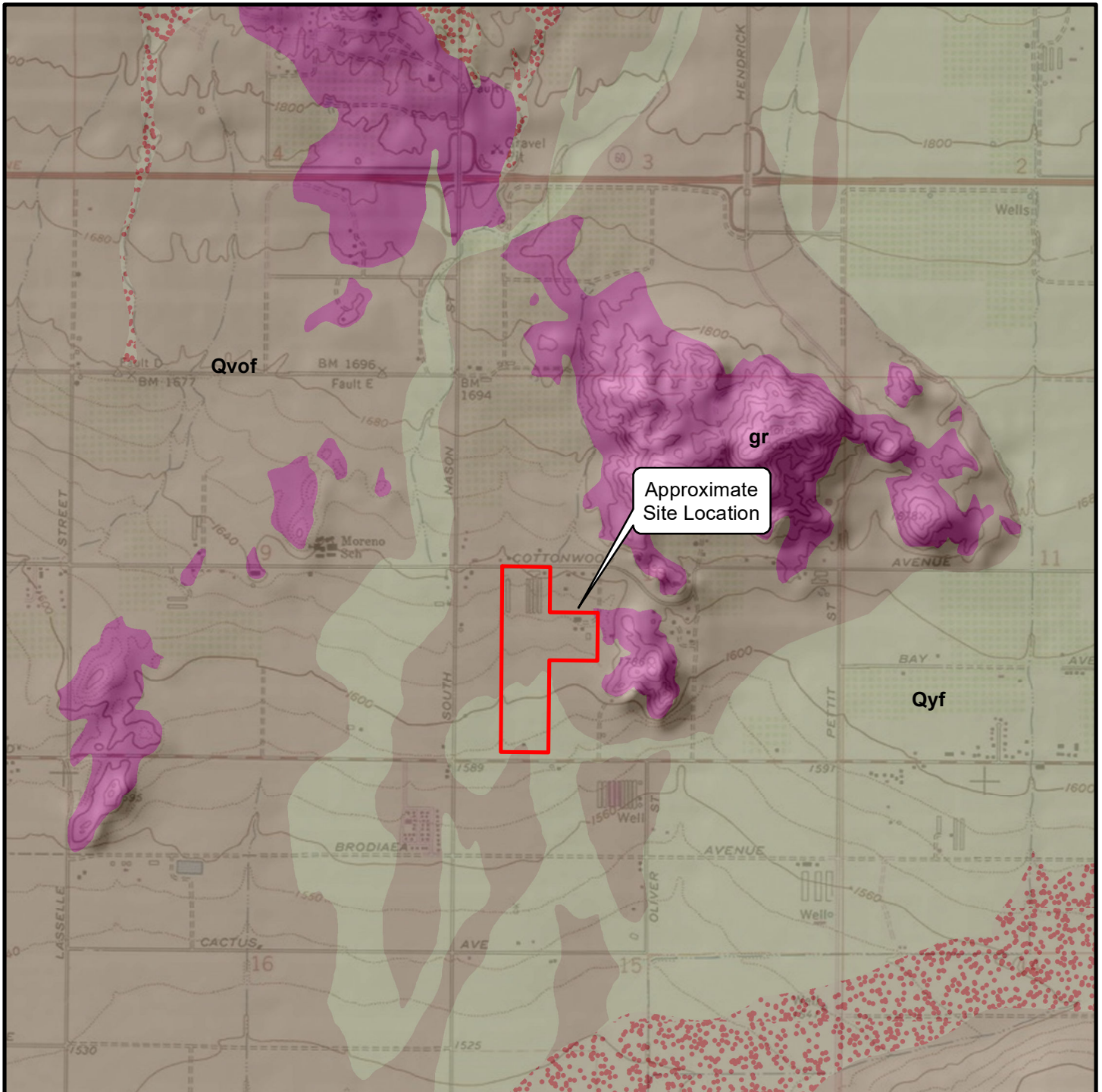
**GEOTECHNICAL MAP**  
 50-Acre Residential Development Project  
 City of Moreno Valley  
 Riverside County, California

**FIGURE 2**



<b>Geologic Units</b>	
	Qvof, Very Old Alluvial Fan Deposits
	Qya, Young Alluvial Valley Deposits
	Qyf, Young Alluvial Fan Deposits
	gr, Granitic and other intrusive crystalline rocks of all ages

Project: 13169.003	Eng/Geol: JLH/SIS
Scale: 1" = 2,000'	Date: March 2022
Reference: Copyright:© 2013 National Geographic Society, i-cubed Geology: Southern California Preliminary Geology by	

**REGIONAL GEOLOGY MAP**  
 50-Acre Residential Development Project  
 City of Moreno Valley  
 Riverside County, California

**FIGURE 3**



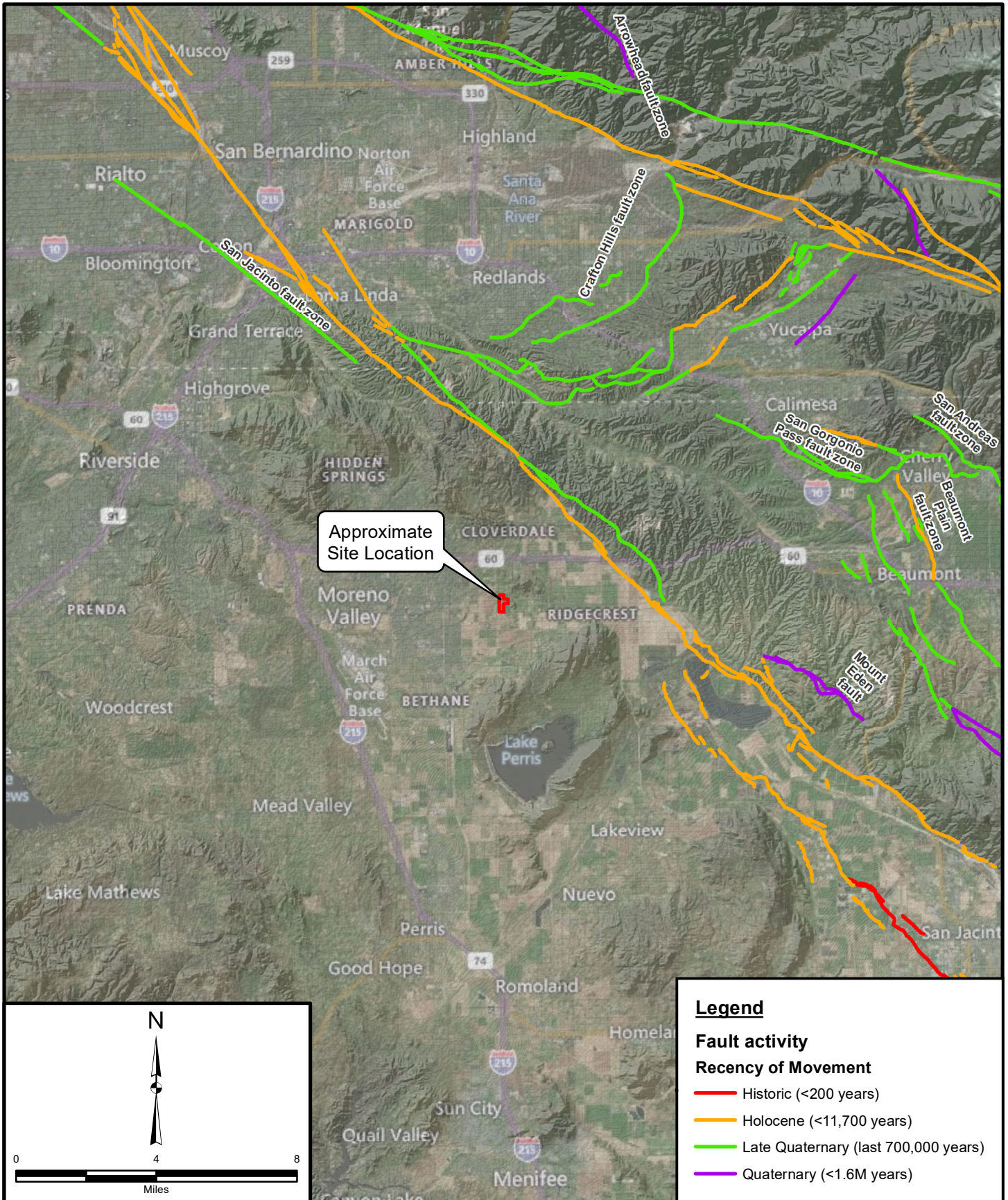

Approximate Site Location

**Legend**

**Fault activity**

**Recency of Movement**

- Historic (<200 years)
- Holocene (<11,700 years)
- Late Quaternary (last 700,000 years)
- Quaternary (<1.6M years)

N

0 4 8

Miles

Project: 13169.003	Eng/Geol: JLH/SIS
Scale: 1" = 4 miles	Date: March 2022
Basemap Reference: © 2022 Microsoft Corporation Earthstar Geographics SIO © 2022 TomTom Seismicity Data Reference: maps.conservation.ca.gov	

**REGIONAL FAULT MAP**  
 50-Acre Residential Development Project  
 City of Moreno Valley  
 Riverside County, California

**FIGURE 4**

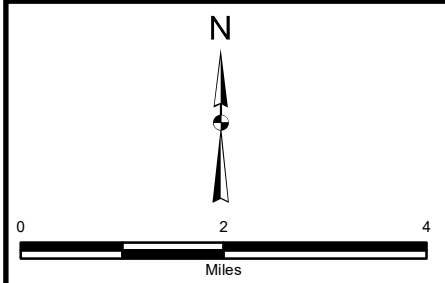
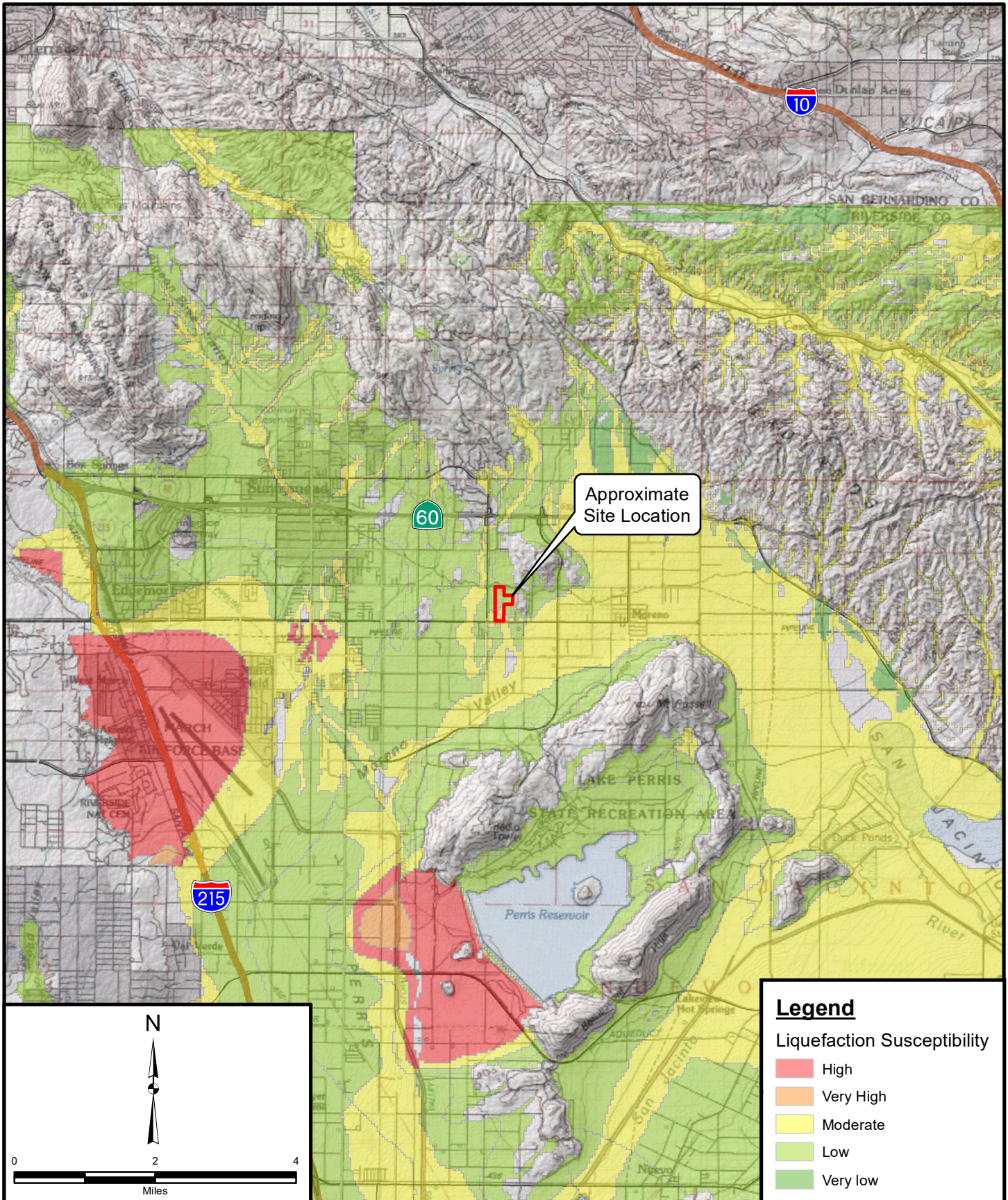

**Legend**

Liquefaction Susceptibility

- High
- Very High
- Moderate
- Low
- Very low

Project: 13169.003	Eng/Geol: JLH
Scale: 1" = 2 miles	Date: March 2022
Reference: Copyright: © 2013 National Geographic Society, i-cubed Liquefaction: Riverside County	

**LIQUEFACTION MAP**  
 50-Acre Residential Development Project  
 City of Moreno Valley  
 Riverside County, California

**FIGURE 5**

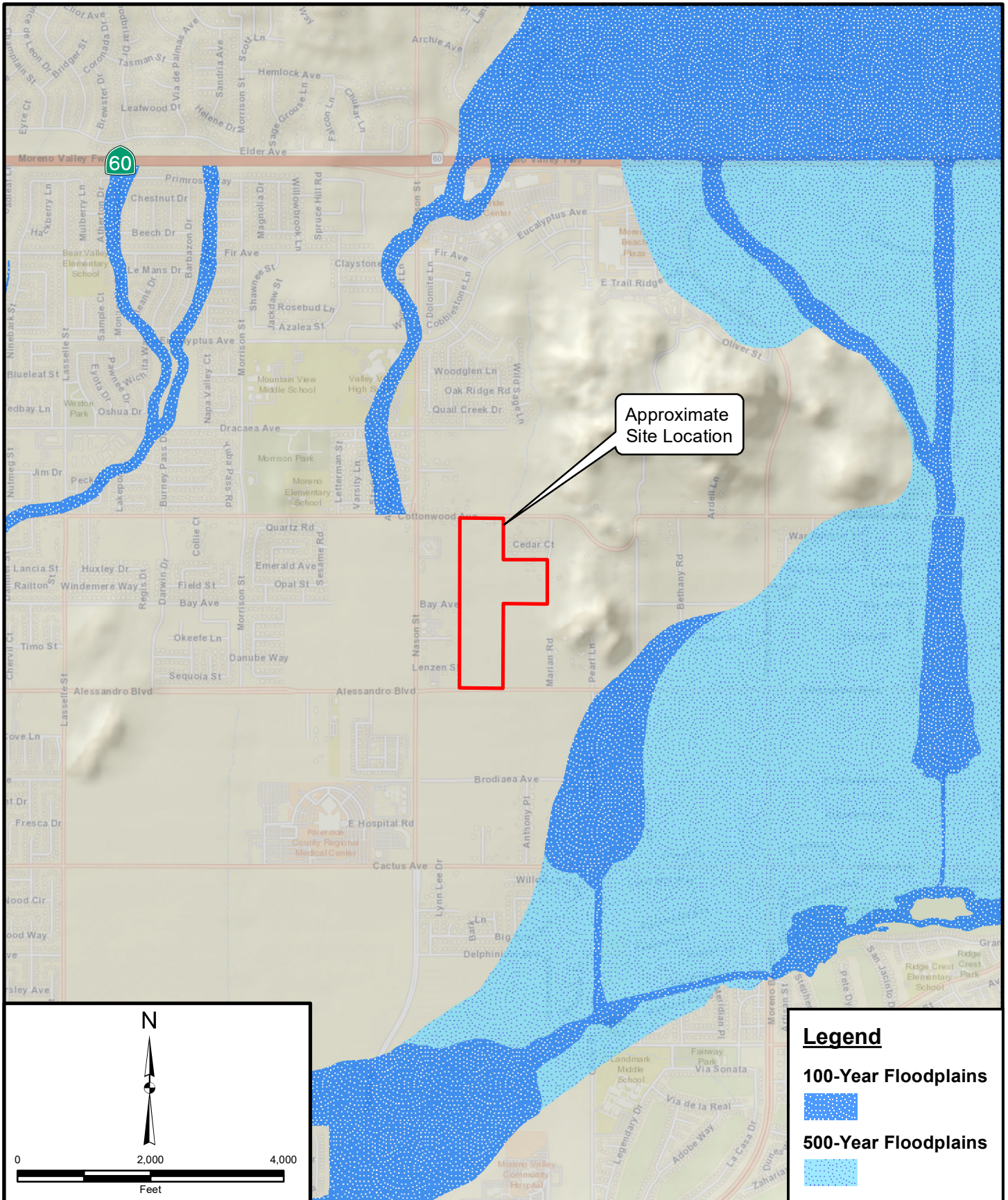

Project: 13169.003	Eng/Geol: JHL/SIS
Scale: 1" = 2,000'	Date: March 2022
<small>Reference: Sources: Esri, HERE, Garmin, USGS, Intermap, INCREMENTAL, P, NRCAn, Esri Japan, METI, Esri China (Hong Kong), Esri Korea, Esri (Thailand), NGCC, (c) OpenStreetMap contributors, and the GIS User Community            FEMA (<a href="http://www.fema.gov/index.shtm">http://www.fema.gov/index.shtm</a>), DWR (<a href="http://www.dwr.ca.gov">http://www.dwr.ca.gov</a>)</small>	

**FLOOD HAZARD ZONE MAP**  
 50-Acre Residential Development Project  
 City of Moreno Valley  
 Riverside County, California

**FIGURE 6**



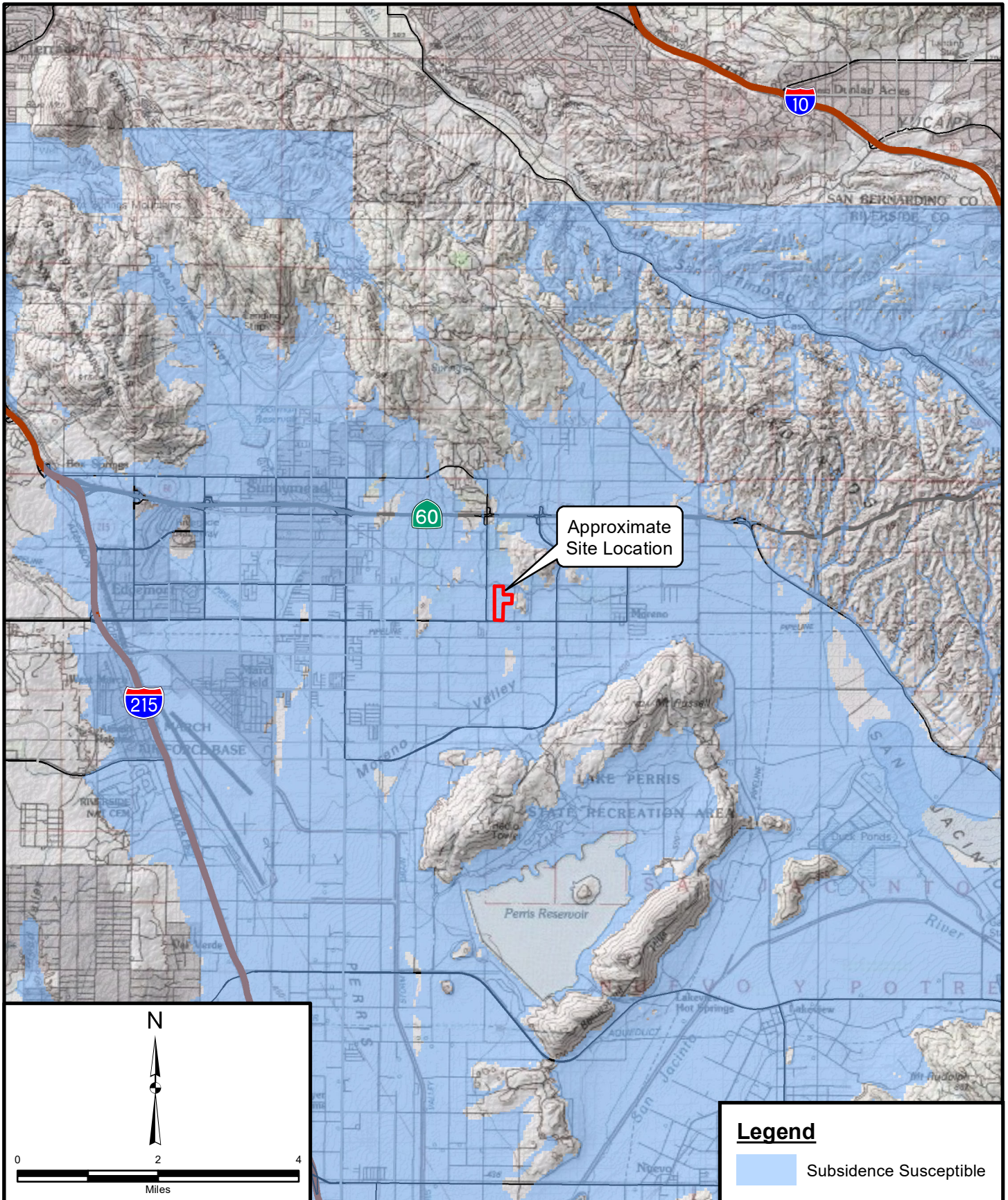

Project: 13169.003	Eng/Geol: JLH/SIS
Scale: 1" = 2 miles	Date: March 2022
Service Layer Credits: Copyright:© 2013 National Geographic Society, i-cubed Subsidence Data: Riverside County	

**SUBSIDENCE MAP**  
 50-Acre Residential Development Project  
 City of Moreno Valley  
 Riverside County, California

**FIGURE 7**



## APPENDIX A

### BORING / TEST PIT / INFILTRATION TEST LOGS

# GEOTECHNICAL BORING LOG LB-1

**Project No.** 13169.003  
**Project** Highpointe MV 1  
**Drilling Co.** Martini Drilling  
**Drilling Method** CME-75 HSA Truck - 140lb - Autohammer - 30" Drop  
**Location** See Figure 2 - Geotechnical Map

**Date Drilled** 3-4-22  
**Logged By** LFO  
**Hole Diameter** 8"  
**Ground Elevation** 1630'  
**Sampled By** LFO/YTN

Elevation Feet	Depth Feet	Graphic Log	Attitudes	Sample No.	Blows Per 6 Inches	Dry Density pcf	Moisture Content, %	Soil Class. (U.S.C.S.)	<b>SOIL DESCRIPTION</b>	Type of Tests
This Soil Description applies only to a location of the exploration at the time of sampling. Subsurface conditions may differ at other locations and may change with time. The description is a simplification of the actual conditions encountered. Transitions between soil types may be gradual.										
1630	0	N S		B-1					<b>Undocumented Artificial Fill (Afu)</b> @0': Vegetation overlying tilled topsoil Silty SAND with Gravel, yellow brown, predominantly fine-to-coarse sand, subrounded gravels, slightly moist	
				R-1	4 3 3	112	4		<b>Quaternary Young Alluvial Fan Deposits (Qya)</b> @2.5': Silty SAND, brown, loose, predominantly fine to medium sand, trace coarse sand, micaceous, slightly moist	
1625	5			R-2	2 2 3	108	5	SM	@5': Silty SAND, brown, loose, predominantly fine sand, trace medium to coarse sand, trace gravel, subrounded gravels up to 0.5 inch diameter, micaceous, slightly moist (CO = 6.2%)	CO
				R-3	3 7 13	122	10		@7.5': Silty SAND, brown, medium dense, predominantly fine to medium sand, few subangular gravels, trace clay, micaceous	
1620	10			R-4	9 12 14			SP-SM	@10': Poorly-graded SAND, yellow brown, medium dense, predominantly fine and medium sand, some coarse sand, trace subrounded gravel, friable, micaceous, moist	
1615	15			S-5	4 5 6			SM	@15': Silty SAND, yellow brown, medium dense, predominantly fine sand, trace coarse sand, trace clay, friable, very moist	
1610	20			S-6	5 10 11			SM	@20': Poorly-graded SAND, yellow brown, medium dense, predominantly fine to medium sand, trace coarse sand, moist @21': Silty SAND, yellow brown, dense, predominantly fine sand, trace coarse sand, trace clay, friable, very moist	
1605	25			S-7	3 4 5			SP-SM	@25': Poorly-graded SAND, yellow brown, medium dense, predominantly fine sand, some medium sand, trace coarse sand, trace rounded gravels, micaceous, moist	
1600	30									

<b>SAMPLE TYPES:</b> B BULK SAMPLE C CORE SAMPLE G GRAB SAMPLE R RING SAMPLE S SPLIT SPOON SAMPLE T TUBE SAMPLE	<b>TYPE OF TESTS:</b> -200 % FINES PASSING AL ATTERBERG LIMITS CN CONSOLIDATION CO COLLAPSE CR CORROSION CU UNDRAINED TRIAXIAL	DS DIRECT SHEAR EI EXPANSION INDEX H HYDROMETER MD MAXIMUM DENSITY PP POCKET PENETROMETER RV R VALUE	SA SIEVE ANALYSIS SE SAND EQUIVALENT SG SPECIFIC GRAVITY UC UNCONFINED COMPRESSIVE STRENGTH
---	--	---	--





# GEOTECHNICAL BORING LOG LB-1

**Project No.** 13169.003  
**Project** Highpointe MV 1  
**Drilling Co.** Martini Drilling  
**Drilling Method** CME-75 HSA Truck - 140lb - Autohammer - 30" Drop  
**Location** See Figure 2 - Geotechnical Map

**Date Drilled** 3-4-22  
**Logged By** LFO  
**Hole Diameter** 8"  
**Ground Elevation** 1630'  
**Sampled By** LFO/YTN

Elevation Feet	Depth Feet	Graphic Log	Attitudes	Sample No.	Blows Per 6 Inches	Dry Density pcf	Moisture Content, %	Soil Class. (U.S.C.S.)	SOIL DESCRIPTION	Type of Tests
1600	30	N S .		S-8	3 5 4				<p><i>This Soil Description applies only to a location of the exploration at the time of sampling. Subsurface conditions may differ at other locations and may change with time. The description is a simplification of the actual conditions encountered. Transitions between soil types may be gradual.</i></p> <p>@30': Poorly-graded SAND, yellow brown, medium dense, predominantly fine sand, some medium sand, trace coarse sand, trace rounded gravels, micaceous, very moist</p> <p><b>Total Depth: 31.5 feet bgs</b>  <b>No groundwater encountered during drilling</b>  <b>Boring backfilled with soil tailings</b></p>	
1595	35									
1590	40									
1585	45									
1580	50									
1575	55									
1570	60									

**SAMPLE TYPES:**

**TYPE OF TESTS:**

- |                      |                       |                        |                                    |
|----------------------|-----------------------|------------------------|------------------------------------|
| B BULK SAMPLE        | -200 % FINES PASSING  | DS DIRECT SHEAR        | SA SIEVE ANALYSIS                  |
| C CORE SAMPLE        | AL ATTERBERG LIMITS   | EI EXPANSION INDEX     | SE SAND EQUIVALENT                 |
| G GRAB SAMPLE        | CN CONSOLIDATION      | H HYDROMETER           | SG SPECIFIC GRAVITY                |
| R RING SAMPLE        | CO COLLAPSE           | MD MAXIMUM DENSITY     | UC UNCONFINED COMPRESSIVE STRENGTH |
| S SPLIT SPOON SAMPLE | CR CORROSION          | PP POCKET PENETROMETER |                                    |
| T TUBE SAMPLE        | CU UNDRAINED TRIAXIAL | RV R VALUE             |                                    |



# GEOTECHNICAL BORING LOG LB-2

**Project No.** 13169.003  
**Project** Highpointe MV 1  
**Drilling Co.** Martini Drilling  
**Drilling Method** CME-75 HSA Truck - 140lb - Autohammer - 30" Drop  
**Location** See Figure 2 - Geotechnical Map

**Date Drilled** 3-4-22  
**Logged By** LFO  
**Hole Diameter** 8"  
**Ground Elevation** 1617'  
**Sampled By** LFO/YTN

Elevation Feet	Depth Feet	Graphic Log	Attitudes	Sample No.	Blows Per 6 Inches	Dry Density pcf	Moisture Content, %	Soil Class. (U.S.C.S.)	<b>SOIL DESCRIPTION</b>	Type of Tests
		N S							This Soil Description applies only to a location of the exploration at the time of sampling. Subsurface conditions may differ at other locations and may change with time. The description is a simplification of the actual conditions encountered. Transitions between soil types may be gradual.	
1615	0			B-1					<b>Undocumented Artificial Fill (Afu)</b> @0': Vegetation overlying tilled topsoil Silty SAND with Gravel, yellow brown, predominantly medium to coarse sand, slightly moist	-200, RV
	5			R-1	7 11 15	117	4	SM	<b>Quaternary Very Old Alluvial Fan Deposits (Qvof)</b> @2.5': Silty SAND, yellow brown, medium dense, predominantly fine to medium sand, some coarse sand, trace granite gravels, slightly moist	
	10			R-2	14 16 22	123	6		@5': Silty SAND, brown, dense, predominantly fine to medium sand, some coarse sand, trace granite gravels, slightly micaceous, moist	
	15			R-3	12 13 15	120	7		@7.5': Silty SAND, yellow brown, medium dense, predominantly fine to medium sand, some coarse sand, slightly micaceous, moist	
	20			R-4	8 13 12	120	7		@10': Silty SAND, yellow brown, medium dense, predominantly fine to medium sand, some coarse sand, trace subrounded gravel, micaceous, moist	
1600	25			R-5	5 8 10	110	11		@15': Silty SAND, yellow brown, medium dense, predominantly fine sand, some medium sand, micaceous, moist (CO = 2.2%)	CO
1595	30			S-6	5 5 6				@20': Silty SAND, yellow brown with gray mottling, medium dense, predominantly fine to medium sand, some coarse sand, subrounded, micaceous, moist	-200
1590				S-7	4 5 6				@25': SAND with Silt, yellow brown, medium dense, predominantly fine to medium sand, some coarse sand, slightly micaceous, moist to very moist	

**SAMPLE TYPES:**

- B BULK SAMPLE
- C CORE SAMPLE
- G GRAB SAMPLE
- R RING SAMPLE
- S SPLIT SPOON SAMPLE
- T TUBE SAMPLE

**TYPE OF TESTS:**

- 200 % FINES PASSING
- AL ATTERBERG LIMITS
- CN CONSOLIDATION
- CO COLLAPSE
- CR CORROSION
- CU UNDRAINED TRIAXIAL

- DS DIRECT SHEAR
- EI EXPANSION INDEX
- H HYDROMETER
- MD MAXIMUM DENSITY
- PP POCKET PENETROMETER
- RV R VALUE

- SA SIEVE ANALYSIS
- SE SAND EQUIVALENT
- SG SPECIFIC GRAVITY
- UC UNCONFINED COMPRESSIVE STRENGTH



# GEOTECHNICAL BORING LOG LB-2

**Project No.** 13169.003  
**Project** Highpointe MV 1  
**Drilling Co.** Martini Drilling  
**Drilling Method** CME-75 HSA Truck - 140lb - Autohammer - 30" Drop  
**Location** See Figure 2 - Geotechnical Map

**Date Drilled** 3-4-22  
**Logged By** LFO  
**Hole Diameter** 8"  
**Ground Elevation** 1617'  
**Sampled By** LFO/YTN

Elevation Feet	Depth Feet	Graphic Log	Attitudes	Sample No.	Blows Per 6 Inches	Dry Density pcf	Moisture Content, %	Soil Class. (U.S.C.S.)	SOIL DESCRIPTION	Type of Tests
		N S							This Soil Description applies only to a location of the exploration at the time of sampling. Subsurface conditions may differ at other locations and may change with time. The description is a simplification of the actual conditions encountered. Transitions between soil types may be gradual.	
1585	30	••••• ••••• •••••		S-8	3 3 5			SP-SM	@30': SAND with Silt, yellow brown, medium dense, predominantly fine to medium sand, some coarse sand, slightly micaceous, moist to very moist  <b>Total Depth: 31.5 feet bgs</b> <b>No groundwater encountered during drilling</b> <b>Boring backfilled with soil tailings</b>	
1580	35									
1575	40									
1570	45									
1565	50									
1560	55									
60	60									

<b>SAMPLE TYPES:</b> B BULK SAMPLE C CORE SAMPLE G GRAB SAMPLE R RING SAMPLE S SPLIT SPOON SAMPLE T TUBE SAMPLE	<b>TYPE OF TESTS:</b> -200 % FINES PASSING AL ATTERBERG LIMITS CN CONSOLIDATION CO COLLAPSE CR CORROSION CU UNDRAINED TRIAXIAL	DS DIRECT SHEAR EI EXPANSION INDEX H HYDROMETER MD MAXIMUM DENSITY PP POCKET PENETROMETER RV R VALUE	SA SIEVE ANALYSIS SE SAND EQUIVALENT SG SPECIFIC GRAVITY UC UNCONFINED COMPRESSIVE STRENGTH
---	--	---	--



# GEOTECHNICAL BORING LOG LB-3

**Project No.** 13169.003  
**Project** Highpointe MV 1  
**Drilling Co.** Martini Drilling  
**Drilling Method** CME-75 HSA Truck - 140lb - Autohammer - 30" Drop  
**Location** See Figure 2 - Geotechnical Map

**Date Drilled** 3-4-22  
**Logged By** LFO  
**Hole Diameter** 8"  
**Ground Elevation** 1599'  
**Sampled By** LFO/YTN

Elevation Feet	Depth Feet	Graphic Log	Attitudes	Sample No.	Blows Per 6 Inches	Dry Density pcf	Moisture Content, %	Soil Class. (U.S.C.S.)	<b>SOIL DESCRIPTION</b>	Type of Tests
	0	N S		B-1					<p><i>This Soil Description applies only to a location of the exploration at the time of sampling. Subsurface conditions may differ at other locations and may change with time. The description is a simplification of the actual conditions encountered. Transitions between soil types may be gradual.</i></p> <p><b>Undocumented Artificial Fill (Afu)</b>                      @0': Vegetation overlying tilled topsoil                      Silty SAND with Gravel, brown, predominantly fine to medium sand, some coarse sand, subrounded granitic gravel, slightly moist</p> <p><b>Quaternary Young Alluvial Fan Deposits (Qyf)</b>                      @2.5': Silty SAND, brown, loose, predominantly fine to medium sand, some coarse sand, trace subrounded gravel, slightly micaceous, slightly moist (MD = 133.2 @ 8.2%)</p> <p>@5': Silty SAND, brown, loose, predominantly fine to medium sand, some coarse sand, trace subrounded gravel, slightly micaceous, moist</p> <p>@7.5': Silty SAND, brown, medium dense, predominantly fine to medium sand, trace coarse sand, moist (CO = 3.8%)</p> <p>@10': Silty SAND, brown, medium dense, predominantly fine to medium sand, trace coarse sand, micaceous, moist (CO = 4.6%)</p> <p>@15': Silty SAND, brown, medium dense, predominantly fine to medium sand, trace coarse sand, micaceous, moist</p> <p>@20': SAND with Silt, brown, medium dense, predominantly fine to medium sand, some coarse sand, slightly micaceous, moist to very moist</p> <p>@25': SAND with Silt, brown, medium dense, predominantly fine to medium sand, some coarse sand, micaceous, moist to very moist</p>	CR, MD, SA
1595	3			R-1	3 3 4	103	4	SM		
1595	5			R-2	4 3 4	102	4			
1590	6			R-3	6 6 7					CO
1590	10			R-4	3 6 9	109	6			CO
1585	15			S-5	2 4 4					
1580	20			S-6	9 8 10			SP-SM		
1575	25			S-7	4 9 10					
1570	30									

**SAMPLE TYPES:**

- B BULK SAMPLE
- C CORE SAMPLE
- G GRAB SAMPLE
- R RING SAMPLE
- S SPLIT SPOON SAMPLE
- T TUBE SAMPLE

**TYPE OF TESTS:**

- 200 % FINES PASSING
- AL ATTERBERG LIMITS
- CN CONSOLIDATION
- CO COLLAPSE
- CR CORROSION
- CU UNDRAINED TRIAXIAL

- DS DIRECT SHEAR
- EI EXPANSION INDEX
- H HYDROMETER
- MD MAXIMUM DENSITY
- PP POCKET PENETROMETER
- RV R VALUE

- SA SIEVE ANALYSIS
- SE SAND EQUIVALENT
- SG SPECIFIC GRAVITY
- UC UNCONFINED COMPRESSIVE STRENGTH



# GEOTECHNICAL BORING LOG LB-3

**Project No.** 13169.003  
**Project** Highpointe MV 1  
**Drilling Co.** Martini Drilling  
**Drilling Method** CME-75 HSA Truck - 140lb - Autohammer - 30" Drop  
**Location** See Figure 2 - Geotechnical Map

**Date Drilled** 3-4-22  
**Logged By** LFO  
**Hole Diameter** 8"  
**Ground Elevation** 1599'  
**Sampled By** LFO/YTN

Elevation Feet	Depth Feet	Graphic Log	Attitudes	Sample No.	Blows Per 6 Inches	Dry Density pcf	Moisture Content, %	Soil Class. (U.S.C.S.)	SOIL DESCRIPTION	Type of Tests
		N S							This Soil Description applies only to a location of the exploration at the time of sampling. Subsurface conditions may differ at other locations and may change with time. The description is a simplification of the actual conditions encountered. Transitions between soil types may be gradual.	
1565	30	.		S-8	4 6 6			SM	@30': Silty SAND, brown, medium dense, predominantly fine to medium sand, some coarse sand, trace clay, trace subrounded gravel, moist  Total Depth: 31.5 feet bgs No groundwater encountered during drilling Boring backfilled with soil tailings	
1560	35									
1555	40									
1550	45									
1545	50									
1540	55									
60										
SAMPLE TYPES:		TYPE OF TESTS:								
B	BULK SAMPLE	-200 % FINES PASSING	DS	DIRECT SHEAR	SA	SIEVE ANALYSIS	EI	EXPANSION INDEX	SE	SAND EQUIVALENT
C	CORE SAMPLE	AL	ATTERBERG LIMITS	H	HYDROMETER	SG	SPECIFIC GRAVITY	UC	UNCONFINED COMPRESSIVE STRENGTH	
G	GRAB SAMPLE	CN	CONSOLIDATION	MD	MAXIMUM DENSITY	PP	POCKET PENETROMETER			
R	RING SAMPLE	CO	COLLAPSE	RV	R VALUE					
S	SPLIT SPOON SAMPLE	CR	CORROSION							
T	TUBE SAMPLE	CU	UNDRAINED TRIAXIAL							



# GEOTECHNICAL BORING LOG LB-4

**Project No.** 13169.003  
**Project** Highpointe MV 1  
**Drilling Co.** Martini Drilling  
**Drilling Method** CME-75 HSA Truck - 140lb - Autohammer - 30" Drop  
**Location** See Figure 2 - Geotechnical Map

**Date Drilled** 3-4-22  
**Logged By** LFO  
**Hole Diameter** 8"  
**Ground Elevation** 1593'  
**Sampled By** LFO/YTN

Elevation Feet	Depth Feet	Graphic Log	Attitudes	Sample No.	Blows Per 6 Inches	Dry Density pcf	Moisture Content, %	Soil Class. (U.S.C.S.)	<b>SOIL DESCRIPTION</b>	Type of Tests
		N S							This Soil Description applies only to a location of the exploration at the time of sampling. Subsurface conditions may differ at other locations and may change with time. The description is a simplification of the actual conditions encountered. Transitions between soil types may be gradual.	
1590	0			B-1					<b>Undocumented Artificial Fill (Afu)</b> @0': Vegetation overlying tilled topsoil Silty SAND, light yellow brown, predominantly fine to medium sand, trace coarse sand, trace subangular gravel, slightly moist	MD, SA
1585	5			R-1	7 11 13	106	5	SM	<b>Quaternary Young Alluvial Fan Deposits (Qyf)</b> @2.5': Silty SAND, yellow brown, medium dense, predominantly fine sand, trace medium to coarse sand, slightly moist (MD = 130 @ 8.5%)  @5': Silty SAND, yellow brown, medium dense, predominantly fine sand, trace medium to coarse sand, trace organic material, slightly micaceous, slightly moist	
1585	7.5			R-2	6 8 11	106	5		@7.5': Silty SAND, brown, loose, predominantly fine sand, trace medium to coarse sand, trace organic material, trace subrounded gravel, slightly micaceous, moist	CO
1580	10			R-3	4 5 6				@10': Silty SAND, brown, loose, predominantly fine to medium sand, some coarse sand, trace subangular gravel, trace clay, slightly micaceous, moist	-200
1575	15			R-4	3 4 7	103	8			
1575	15			R-5	8 12 20			SC-SM	<b>Quaternary Very Old Alluvial Fan Deposits (Qvof)</b> @15': Silty Clayey SAND, reddish brown, dense, predominantly fine sand, trace gravel up to 1 inch diameter, low plasticity, moist	
1570	20			S-6	6 5 9			SP-SM	@20': Poorly-graded SAND with Silt, orange brown, medium dense, predominantly fine to medium sand, trace coarse sand, trace subangular gravel, micaceous, slightly moist	
1565	25			R-7	15 27 19				@25': Poorly-graded SAND with Silt, reddish brown, dense, predominantly fine to medium sand, some coarse sand, some subangular gravel, moist	
1565	30									

**SAMPLE TYPES:**

- B BULK SAMPLE
- C CORE SAMPLE
- G GRAB SAMPLE
- R RING SAMPLE
- S SPLIT SPOON SAMPLE
- T TUBE SAMPLE

**TYPE OF TESTS:**

- 200 % FINES PASSING
- AL ATTERBERG LIMITS
- CN CONSOLIDATION
- CO COLLAPSE
- CR CORROSION
- CU UNDRAINED TRIAXIAL

- DS DIRECT SHEAR
- EI EXPANSION INDEX
- H HYDROMETER
- MD MAXIMUM DENSITY
- PP POCKET PENETROMETER
- RV R VALUE

- SA SIEVE ANALYSIS
- SE SAND EQUIVALENT
- SG SPECIFIC GRAVITY
- UC UNCONFINED COMPRESSIVE STRENGTH



# GEOTECHNICAL BORING LOG LB-4

**Project No.** 13169.003  
**Project** Highpointe MV 1  
**Drilling Co.** Martini Drilling  
**Drilling Method** CME-75 HSA Truck - 140lb - Autohammer - 30" Drop  
**Location** See Figure 2 - Geotechnical Map

**Date Drilled** 3-4-22  
**Logged By** LFO  
**Hole Diameter** 8"  
**Ground Elevation** 1593'  
**Sampled By** LFO/YTN

Elevation Feet	Depth Feet	Graphic Log	Attitudes	Sample No.	Blows Per 6 Inches	Dry Density pcf	Moisture Content, %	Soil Class. (U.S.C.S.)	<b>SOIL DESCRIPTION</b>	Type of Tests
		N S							This Soil Description applies only to a location of the exploration at the time of sampling. Subsurface conditions may differ at other locations and may change with time. The description is a simplification of the actual conditions encountered. Transitions between soil types may be gradual.	
1560	30			S-8	5 9 7			SM	@30': Silty SAND, reddish brown, medium dense, predominantly fine sand, trace medium to coarse sand, trace clay, trace subangular gravel, micaceous, moist	
1555	35			S-9	4 7 10				@35': Silty SAND, reddish brown, medium dense, predominantly fine sand, trace medium to coarse sand, trace clay, trace subangular gravel, micaceous, moist	
1550	40			S-10	6 9 8				@40': Silty SAND, reddish brown, medium dense, predominantly fine sand, trace medium to coarse sand, trace clay, trace subangular gravel, micaceous, moist @40.5': Pocket of gravel within Silty SAND	
1545	45			S-11	14 17 11			SP-SM	@45': Poorly-graded SAND, gray brown, dense, predominantly fine sand, some medium sand, trace coarse sand, trace clay, trace gravel, moist	
1540	50			S-12	8 12 9			SM	@50': Silty SAND, reddish orange brown, dense, predominantly fine sand, some medium to coarse sand, micaceous, moist	
1535	55								<b>Total Depth: 51.5 feet bgs</b> <b>No groundwater encountered during drilling</b> <b>Boring backfilled with soil tailings</b>	
1530	60									

**SAMPLE TYPES:**

- B BULK SAMPLE
- C CORE SAMPLE
- G GRAB SAMPLE
- R RING SAMPLE
- S SPLIT SPOON SAMPLE
- T TUBE SAMPLE

**TYPE OF TESTS:**

- 200 % FINES PASSING
- AL ATTERBERG LIMITS
- CN CONSOLIDATION
- CO COLLAPSE
- CR CORROSION
- CU UNDRAINED TRIAXIAL

- DS DIRECT SHEAR
- EI EXPANSION INDEX
- H HYDROMETER
- MD MAXIMUM DENSITY
- PP POCKET PENETROMETER
- RV R VALUE

- SA SIEVE ANALYSIS
- SE SAND EQUIVALENT
- SG SPECIFIC GRAVITY
- UC UNCONFINED COMPRESSIVE STRENGTH



# GEOTECHNICAL BORING LOG LP-1

**Project No.** 13169.003  
**Project** Highpointe MV 1  
**Drilling Co.** Martini Drilling  
**Drilling Method** CME-75 HSA Truck - 140lb - Autohammer - 30" Drop  
**Location** See Figure 2 - Geotechnical Map

**Date Drilled** 3-4-22  
**Logged By** LFO  
**Hole Diameter** 8"  
**Ground Elevation** 1614'  
**Sampled By** LFO/YTN

Elevation Feet	Depth Feet	Graphic Log	Attitudes	Sample No.	Blows Per 6 Inches	Dry Density pcf	Moisture Content, %	Soil Class. (U.S.C.S.)	SOIL DESCRIPTION	Type of Tests
	0	N S							<p><i>This Soil Description applies only to a location of the exploration at the time of sampling. Subsurface conditions may differ at other locations and may change with time. The description is a simplification of the actual conditions encountered. Transitions between soil types may be gradual.</i></p> <p><b>Undocumented Artificial Fill (Afu)</b>                      @0': Vegetation overlying tilled topsoil                      SAND with Silt, yellowbrown, predominantly fine to medium sand, some subangular gravel, organic material, slightly moist</p> <p><b>Quaternary Young Alluvial Fan Deposits (Qya)</b></p>	
1610	5			R-1	6 9 11			SM	@5': Silty SAND, brown, medium dense, predominantly fine sand, trace medium to coarse sand, slightly micaceous, slightly moist	
1605	10			R-2 B-1	5 6 8				@10': Silty SAND, brown, medium dense, predominantly fine sand, trace coarse sand, moist (CO = 2.7%)  @12': Grades to Silty SAND with Gravel, reddish brown, predominantly fine sand, moist	CO -200
1600	15								<p><b>Total Depth: 13 feet bgs</b>  <b>No groundwater encountered during drilling</b>  <b>Boring converted to percolation test well with 0.020 slotted screen from 8 to 13 feet bgs</b></p>	
1595	20									
1590	25									
1585	30									

**SAMPLE TYPES:**

- B BULK SAMPLE
- C CORE SAMPLE
- G GRAB SAMPLE
- R RING SAMPLE
- S SPLIT SPOON SAMPLE
- T TUBE SAMPLE

**TYPE OF TESTS:**

- 200 % FINES PASSING
- AL ATTERBERG LIMITS
- CN CONSOLIDATION
- CO COLLAPSE
- CR CORROSION
- CU UNDRAINED TRIAXIAL

- DS DIRECT SHEAR
- EI EXPANSION INDEX
- H HYDROMETER
- MD MAXIMUM DENSITY
- PP POCKET PENETROMETER
- RV R VALUE

- SA SIEVE ANALYSIS
- SE SAND EQUIVALENT
- SG SPECIFIC GRAVITY
- UC UNCONFINED COMPRESSIVE STRENGTH





# GEOTECHNICAL BORING LOG LP-2

**Project No.** 13169.003  
**Project** Highpointe MV 1  
**Drilling Co.** Martini Drilling  
**Drilling Method** CME-75 HSA Truck - 140lb - Autohammer - 30" Drop  
**Location** See Figure 2 - Geotechnical Map

**Date Drilled** 3-4-22  
**Logged By** LFO  
**Hole Diameter** 8"  
**Ground Elevation** 1589'  
**Sampled By** LFO/YTN

Elevation Feet	Depth Feet	Graphic Log	Attitudes	Sample No.	Blows Per 6 Inches	Dry Density pcf	Moisture Content, %	Soil Class. (U.S.C.S.)	SOIL DESCRIPTION	Type of Tests
		N S							This Soil Description applies only to a location of the exploration at the time of sampling. Subsurface conditions may differ at other locations and may change with time. The description is a simplification of the actual conditions encountered. Transitions between soil types may be gradual.	
1585	0			B-1					<b>Undocumented Artificial Fill (Afu)</b> @0': Vegetation overlying tilled topsoil Silty SAND, dark brown, predominantly fine sand, trace medium sand, slightly moist <b>Quaternary Young Alluvial Fan Deposits (Qyf)</b> @0.5': Silty SAND, brown, predominantly fine sand, moist	
1580	5			R-1	4 5 8			SM	@5': Silty SAND, brown, medium dense, predominantly fine sand, trace coarse sand, trace rootlets, pinhole pores, slightly moist (CO = 9.3%)	CO
1575	10			B-1 R-2	7 14 18	126	10	SC-SM	<b>Quaternary Very Old Alluvial Fan Deposits (Qvof)</b> @10': CLAY with Sand, reddish brown, medium dense, predominantly fine sand, trace CaCO3 encrustation, slightly micaceous, low plasticity, moist @11.5': Grades to Silty SAND with Gravel, brown, predominantly fine sand, trace coarse sand, rounded fine gravels, moist	-200
1570	15								<b>Total Depth: 13 feet bgs</b> No groundwater encountered during drilling Boring converted to percolation test well with 0.020 slotted screen from 8 to 13 feet bgs	
1565	20									
1560	25									
1555	30									

**SAMPLE TYPES:**

- B BULK SAMPLE
- C CORE SAMPLE
- G GRAB SAMPLE
- R RING SAMPLE
- S SPLIT SPOON SAMPLE
- T TUBE SAMPLE

**TYPE OF TESTS:**

- 200 % FINES PASSING
- AL ATTERBERG LIMITS
- CN CONSOLIDATION
- CO COLLAPSE
- CR CORROSION
- CU UNDRAINED TRIAXIAL

- DS DIRECT SHEAR
- EI EXPANSION INDEX
- H HYDROMETER
- MD MAXIMUM DENSITY
- PP POCKET PENETROMETER
- RV R VALUE

- SA SIEVE ANALYSIS
- SE SAND EQUIVALENT
- SG SPECIFIC GRAVITY
- UC UNCONFINED COMPRESSIVE STRENGTH



LOG OF TRENCH: TP-1

Project Name: <u>Highpointe MV 50</u>		Logged by: <u>EMH</u>		FIELD ENGINEERING PROPERTIES			
Project Number: <u>13169.003</u>		Elevation: <u>Approx. 1625 ft</u>					
Equipment: <u>Backhoe</u>		Location/Grid: <u>See Figure 2 - Geotechnical Map</u>		USCS	In-Situ Density Test No.	Depth/Moisture (%) / Dry Density	Lab Tests
GEOLOGIC ATTITUDES	DATE: <u>03.04.2022</u>	DESCRIPTION:					
	1) 0'-1': Tilled material/ surficial soil. Sandy SILT (ML), light brown, slightly moist, fine sand, abundant rootlets		Afu	ML			
	2) 1'-5': Silty Clayey SAND w/ Gravel (SC), reddish brown, moist, hard, fine to medium sand w/ occasional coarse sand and sporadic fine gravel, massive, debris flow, low to medium plasticity. Backhoe operator indicates hard digging.		Qvof	SC			BB-1 (1'-5')

GRAPHICAL REPRESENTATION: South Wall      SCALE: 1 inch = 2 feet      SURFACE SLOPE:      TREND: East-West

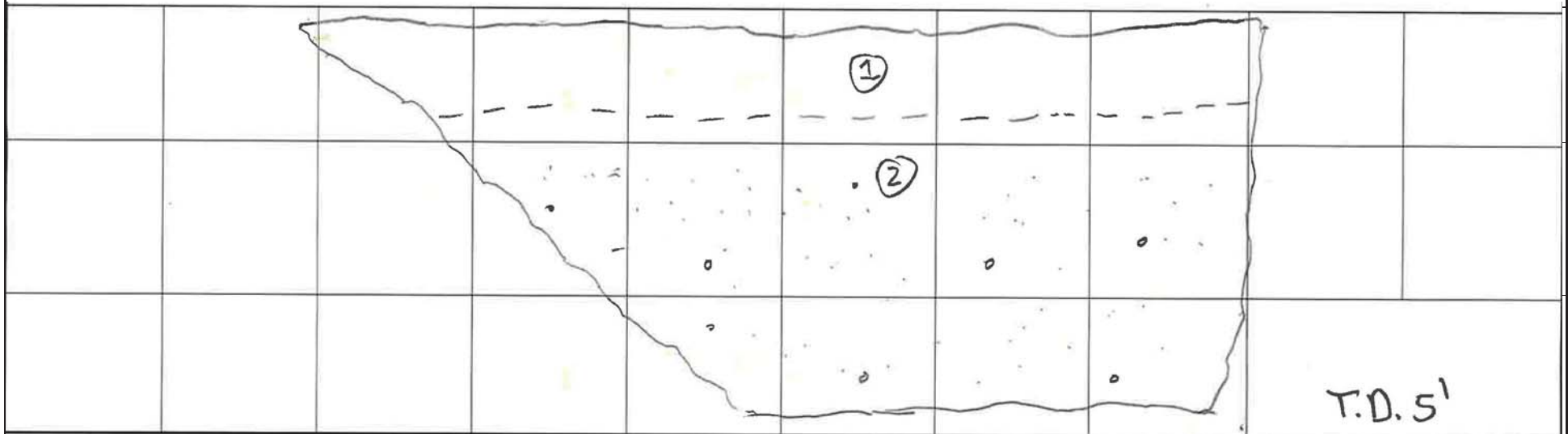

LOG OF TRENCH: TP-2

Project Name: <u>Highpointe MV 50</u>		Logged by: <u>EMH</u>		FIELD ENGINEERING PROPERTIES			
Project Number: <u>13169.003</u>		Elevation: <u>Approx. 1624 ft</u>					
Equipment: <u>Backhoe</u>		Location/Grid: <u>See Figure 2 - Geotechnical Map</u>		USCS	In-Situ Density Test No.	Depth/Moisture (%) / Dry Density	Lab Tests
GEOLOGIC ATTITUDES	DATE: <u>03.04.2022</u>	DESCRIPTION:					
	1) 0'-2': Tilled/ Loose Surficial Material: Silty SAND (SM), light brown, slightly moist, fine to medium sand w/ pockets of fine to coarse sand and fine gravel		Afu	SM			
	2) 2'-5': Silty SAND (SM), light brown to light reddish brown, slightly moist, mostly fine to medium sand, few coarse sand and sporadic fine gravel, reverse graded, little clay		Qyf	SM			BB-1 (2'-5')

GRAPHICAL REPRESENTATION: East Wall

SCALE: 1 inch = 2 feet

SURFACE SLOPE:

TREND: North-South

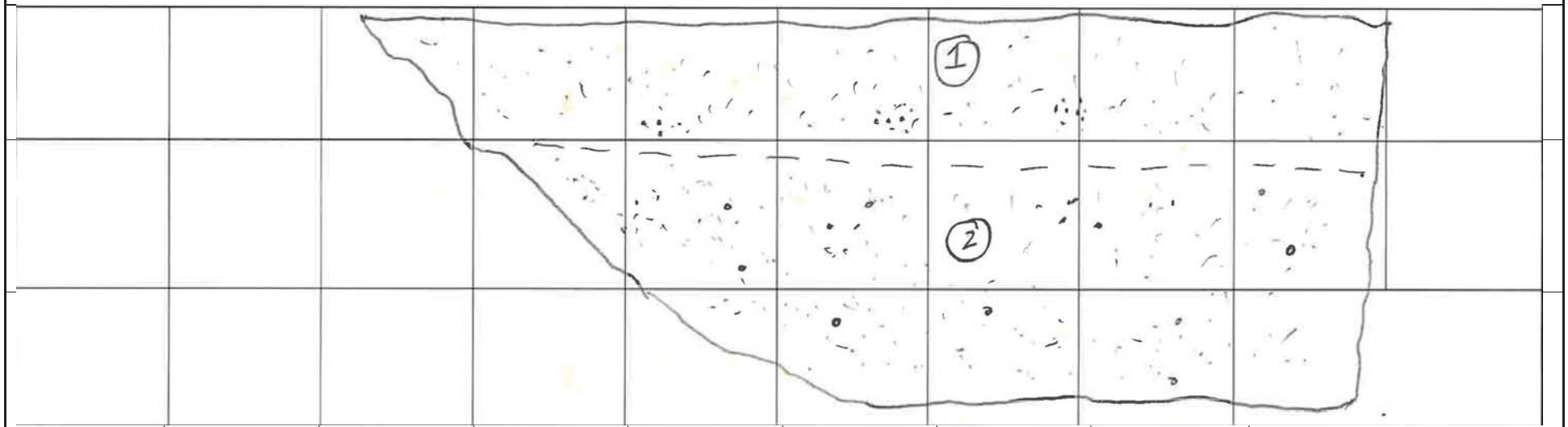

LOG OF TRENCH: TP-3

Project Name: <u>Highpointe MV 50</u>		Logged by: <u>EMH</u>		FIELD ENGINEERING PROPERTIES			
Project Number: <u>13169.003</u>		Elevation: <u>Approx. 1609 ft</u>					
Equipment: <u>Backhoe</u>		Location/Grid: <u>See Figure 2 - Geotechnical Map</u>		USCS	In-Situ Density Test No.	Depth/Moisture (%) / Dry Density	Lab Tests
GEOLOGIC ATTITUDES	DATE: <u>03.04.2022</u>	DESCRIPTION:	GEOLOGIC UNIT				
		1) 0'-8": Loose Surficial Soil: Silty SAND (SM), light brown, slightly moist, fine to medium sand, trace coarse sand and fine gravel, abundant rootlets	Afu	SM			
		2) 8"-4.5': Clayey Sandy SILT (ML), reddish brown, slightly moist, fine to coarse sand w/ occasional fine gravel, massive, debris flow chaotic assemblage, low plasticity	Qyf	ML			BB-1 (1'-4.5')

GRAPHICAL REPRESENTATION: South Wall      SCALE: 1 inch = 2 feet      SURFACE SLOPE:      TREND: East-West

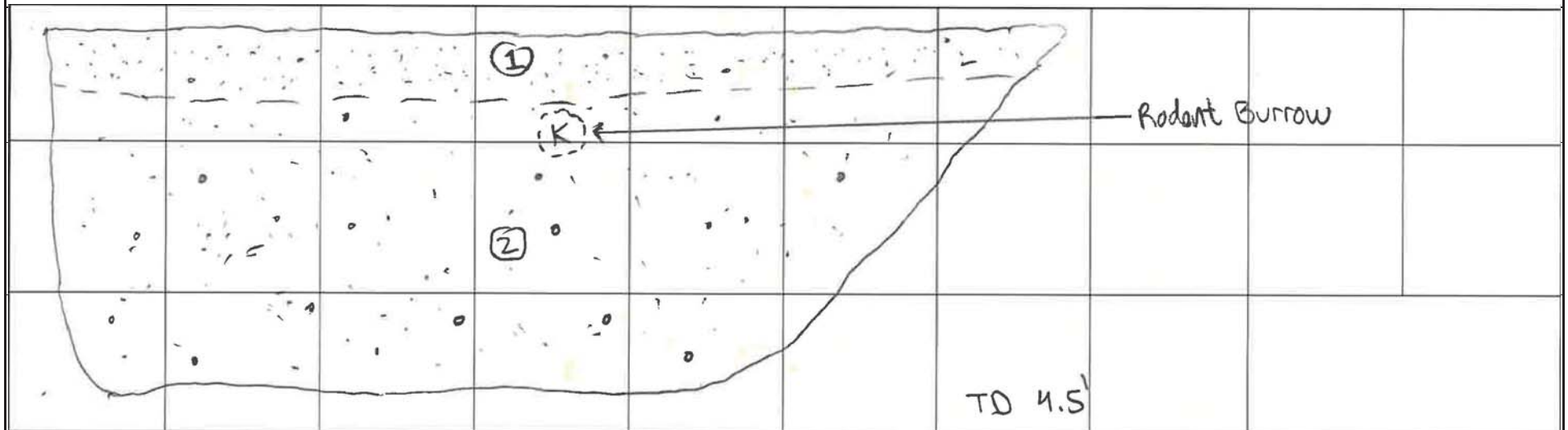

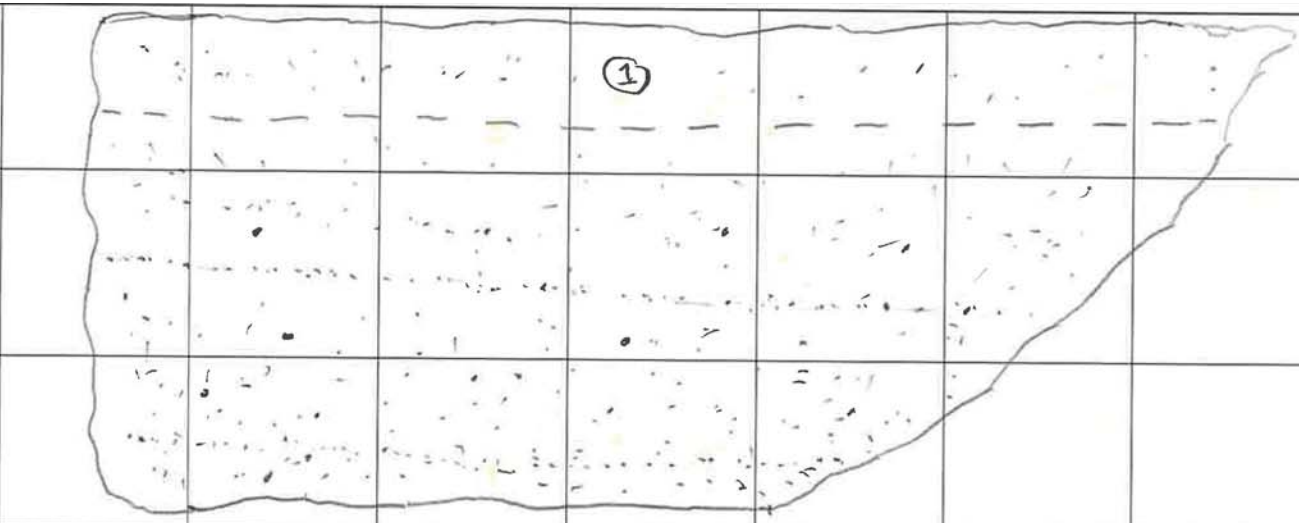
				LOG OF TRENCH: TP-5			
Project Name: <u>Highpointe MV 50</u>		Logged by: <u>EMH</u>		FIELD ENGINEERING PROPERTIES			
Project Number: <u>13169.003</u>		Elevation: <u>Approx. 1595 ft</u>					
Equipment: <u>Backhoe</u>		Location/Grid: <u>See Figure 2 - Geotechnical Map</u>		USCS	In-Situ Density Test No.	Depth/Moisture (%) / Dry Density	Lab Tests
GEOLOGIC ATTITUDES	DATE: <u>03.04.2022</u>	DESCRIPTION:	GEOLOGIC UNIT				
		1) 0'-1': Tilled Material: Silty SAND (SM), light brown, slightly moist, fine to medium sand, trace coarse sand and gravel	Afu	SM			
		2) 1'-5': Silty SAND (SM), light brown to light reddish brown, slightly moist to moist, mostly fine to medium sand, with coarse sand and fine gravel, mostly massive w/ occasional faint laminations, trace clay binder	Qyf	SM			BB-1 (3'-5')
GRAPHICAL REPRESENTATION: East Wall				SCALE: 1 inch = 2 feet	SURFACE SLOPE:		TREND: North-South
							

**Boring Percolation Test Data Sheet**

<b>Project Number:</b>	13169.003	<b>Test Hole Number:</b>	LP-1
<b>Project Name:</b>	Highpoint MV 50	<b>Date Excavated:</b>	3/14/2021
<b>Earth Description:</b>	Alluvium	<b>Date Tested:</b>	3/15/2021
<b>Liquid Description:</b>	Tap water	<b>Depth of boring (ft):</b>	13
<b>Tested By:</b>	LFO	<b>Radius of boring (in):</b>	4
<b><u>Time Interval Standard</u></b>		<b>Radius of casing (in):</b>	1
<b>Start Time for Pre-Soak:</b>	11:15 AM	<b>Length of slotted of casing (ft):</b>	5
<b>Start Time for Standard:</b>	11:15 AM	<b>Depth to Initial Water Depth (ft):</b>	8
<b>Standard Time Interval</b>	25 mins	<b>Porosity of Annulus Material, n :</b>	0.35
<b>Between Readings, mins:</b>	10	<b>Bentonite Plug at Bottom:</b>	No

**Field Percolation Data - Falling Head Test**

Reading	Time	Time Interval, Δt (min.)	Initial/Final Depth to Water (ft.)	Initial/Final Water Height, H <sub>0</sub> /H <sub>f</sub> (in.)	Total Water Drop, Δd (in.)	Infiltration Rate (in./hr.)
P1	11:17	25	9.25	45.0	24.6	1.33
	11:42		11.30	20.4		
P2	11:51	25	9.85	37.8	19.9	1.25
	12:16		11.51	17.9		
1	12:44	10	10.00	36.0	9.0	1.26
	12:54		10.75	27.0		
2	12:55	10	9.81	38.3	8.6	1.13
	13:05		10.53	29.6		
3	13:06	10	10.05	35.4	10.8	1.58
	13:16		10.95	24.6		
4	13:20	10	9.95	36.6	8.4	1.14
	13:30		10.65	28.2		
5	13:32	12	10.07	35.2	11.0	1.36
	13:44		10.99	24.1		
6	13:50	10	9.95	36.6	9.7	1.35
	14:00		10.76	26.9		

Infiltration Rate (I) = Discharge Volume/Surface Area of Test Section/Time Interval

**Measured Infiltration Rate, I (Average of Last 3 Readings) = 1.29 in./hr.**

**Boring Percolation Test Data Sheet**

<b>Project Number:</b>	13169.003	<b>Test Hole Number:</b>	LP-2
<b>Project Name:</b>	Highpoint MV 50	<b>Date Excavated:</b>	3/14/2021
<b>Earth Description:</b>	Alluvium	<b>Date Tested:</b>	3/15/2021
<b>Liquid Description:</b>	Tap water	<b>Depth of boring (ft):</b>	13
<b>Tested By:</b>	LFO	<b>Radius of boring (in):</b>	4
<b>Time Interval Standard</b>		<b>Radius of casing (in):</b>	1
<b>Start Time for Pre-Soak:</b>	10:21 AM	<b>Length of slotted of casing (ft):</b>	5
<b>Start Time for Standard:</b>	10:21 AM	<b>Depth to Initial Water Depth (ft):</b>	8
<b>Standard Time Interval</b>	25 mins	<b>Porosity of Annulus Material, <i>n</i> :</b>	0.35
<b>Between Readings, mins:</b>	30	<b>Bentonite Plug at Bottom:</b>	No

Field Percolation Data - Falling Head Test

Reading	Time	Time Interval, Δt (min.)	Initial/Final Depth to Water (ft.)	Initial/Final Water Height, H <sub>0</sub> /H <sub>f</sub> (in.)	Total Water Drop, Δd (in.)	Infiltration Rate (in./hr.)
P1	10:21	25	10.01	35.9	2.8	0.14
	10:46		10.24	33.1		
P2	10:48	25	9.72	39.4	1.0	0.04
	11:12		9.80	38.4		
1	11:27	30	9.90	37.2	1.0	0.04
	11:57		9.98	36.2		
2	12:02	30	9.90	37.2	1.3	0.05
	12:32		10.01	35.9		
3	12:33	30	10.01	35.9	3.4	0.15
	13:03		10.29	32.5		
4	13:08	30	9.96	36.5	2.8	0.12
	13:38		10.19	33.7		
5	13:40	30	9.96	36.5	1.8	0.07
	14:10		10.11	34.7		
6	14:13	30	10.01	35.9	1.7	0.07
	14:43		10.15	34.2		
7	14:45	30	10.00	36.0	2.0	0.09
	15:15		10.17	34.0		
8	15:17	30	9.99	36.1	2.0	0.09
	15:47		10.16	34.1		
9	15:49	30	9.98	36.2	1.8	0.08
	16:19		10.13	34.4		
10	16:20	30	10.00	36.0	1.9	0.08
	16:50		10.16	34.1		
11	16:51	30	10.00	36.0	1.8	0.08
	17:21		10.15	34.2		
12	17:22	30	9.99	36.1	1.9	0.08
	17:52		10.15	34.2		

Infiltration Rate (I) = Discharge Volume/Surface Area of Test Section/Time Interval

Measured Infiltration Rate, I (Average of Last 3 Readings) = 0.08 in./hr.

APPENDIX B

LABORATORY TEST RESULTS



Boring No.	LB-2	LB-2	LB-4	LP-1	LP-2			
Sample No.	B-1	S-6	S-10	B-1	B-2			
Depth (ft.)	0 - 5.0	20.0	40.0	10.0 - 13.0	10.0 - 13.0			
Sample Type	Bulk	SPT	SPT	Bulk	Bulk			
Soil Classification	SM	SM	SM	SM	SM			
Soak Time (min)	10	10	10	10	10			
<b>Moisture Correction</b>								
Wet Weight of Soil + Container (gm.)	595.4	524.9	543.2	528.1	539.9			
Dry Weight of Soil + Container (gm.)	579.6	511.1	529.9	518.0	531.9			
Weight of Container (gm)	277.3	329.2	332.7	327.9	420.9			
Moisture Content (%)	5.2	7.6	6.7	5.3	7.2			
Container No.:	A	W	A1	F	S			
<b>Sample Dry Weight Determination</b>								
Weight of Sample + Container (gm.)	579.6	511.1	529.9	518.0	531.9			
Weight of Container (gm.)	277.3	329.2	332.7	327.9	420.9			
Weight of Dry Sample (gm.)	302.3	181.9	197.2	190.1	111.0			
Container No.:	A	W	A1	F	S			
<b>After Wash</b>								
Dry Weight of Sample + Container (gm)	484.5	466.9	476.3	445.1	486.9			
Weight of Container (gm)	277.3	329.2	332.7	327.9	420.9			
Dry Weight of Sample (gm)	207.2	137.7	143.6	117.2	66.0			
<b>% Passing No. 200 Sieve</b>	<b>31</b>	<b>24</b>	<b>27</b>	<b>38</b>	<b>41</b>			
<b>% Retained No. 200 Sieve</b>	<b>69</b>	<b>76</b>	<b>73</b>	<b>62</b>	<b>59</b>			
	<b>PERCENT PASSING No. 200 SIEVE ASTM D 1140</b>				Project Name: <u>Highpointe MV 1 Geo</u>			
					Project No.: <u>13169.003</u>			
					Client Name: <u>Highpointe Communities</u>			
					Tested By: <u>M. Vinet</u>		Date: <u>03/22/22</u>	



**One-Dimensional Swell or Settlement  
Potential of Cohesive Soils  
(ASTM D 4546) -- Method 'B'**

Project Name: Highpointe MV 1 Geo Tested By: M. Vinet Date: 3/21/22  
 Project No.: 13169.003 Checked By: M. Vinet Date: 3/23/22  
 Boring No.: LB-1 Sample Type: IN SITU  
 Sample No.: R-2 Depth (ft.) 5.0

Sample Description: Silty Sand (SM), Brown.  
 Source and Type of Water Used for Inundation: Arrowhead ( Distilled )

**\*\* Note:** Loading After Wetting (Inundation) not Performed Using this Test Method.

Initial Dry Density (pcf):	99.6
Initial Moisture (%):	6.9
Initial Height (in.):	1.0000
Initial Dial Reading (in):	0.0000
Inside Diameter of Ring (in):	2.416

Final Dry Density (pcf):	109.3
Final Moisture (%) :	14.9
Initial Void ratio:	0.6932
Specific Gravity (assumed):	2.70
Initial Degree of Saturation (%):	27.0

Pressure (p) (ksf)	Final Reading (in)	Apparent Thickness (in)	Load Compliance (%)	Swell (+) Settlement (-) % of Sample Thickness	Void Ratio	Corrected Deformation (%)
1.050	0.0167	0.9833	0.00	-1.67	0.6649	-1.67
2.013	0.0295	0.9705	0.00	-2.95	0.6432	-2.95
H2O	0.0893	0.9107	0.00	-8.93	0.5420	-8.93

**Percent Swell / Settlement After Inundation = -6.16**

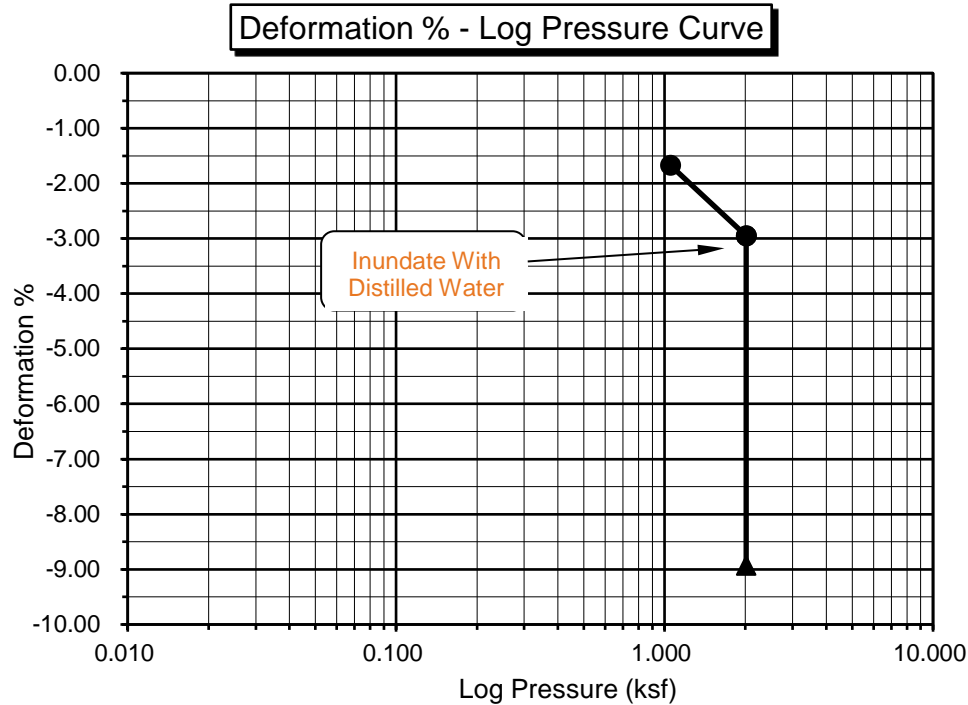



**One-Dimensional Swell or Settlement  
Potential of Cohesive Soils  
(ASTM D 4546) -- Method 'B'**

Project Name: Highpointe MV 1 Geo Tested By: M. Vinet Date: 3/21/22  
 Project No.: 13169.003 Checked By: M. Vinet Date: 3/23/22  
 Boring No.: LB-2 Sample Type: IN SITU  
 Sample No.: R-5 Depth (ft.) 15.0

Sample Description: Silty Sand (SM), Brown.  
 Source and Type of Water Used for Inundation: Arrowhead ( Distilled )

**\*\* Note:** Loading After Wetting (Inundation) not Performed Using this Test Method.

Initial Dry Density (pcf):	105.7	Final Dry Density (pcf):	111.1
Initial Moisture (%):	10.3	Final Moisture (%) :	16.0
Initial Height (in.):	1.0000	Initial Void ratio:	0.5952
Initial Dial Reading (in):	0.0000	Specific Gravity (assumed):	2.70
Inside Diameter of Ring (in):	2.416	Initial Degree of Saturation (%):	46.5

Pressure (p) (ksf)	Final Reading (in)	Apparent Thickness (in)	Load Compliance (%)	Swell (+) Settlement (-) % of Sample Thickness	Void Ratio	Corrected Deformation (%)
1.050	0.0187	0.9813	0.00	-1.87	0.5653	-1.87
2.013	0.0275	0.9725	0.00	-2.75	0.5513	-2.75
H2O	0.0489	0.9511	0.00	-4.89	0.5172	-4.89

**Percent Swell / Settlement After Inundation = -2.20**

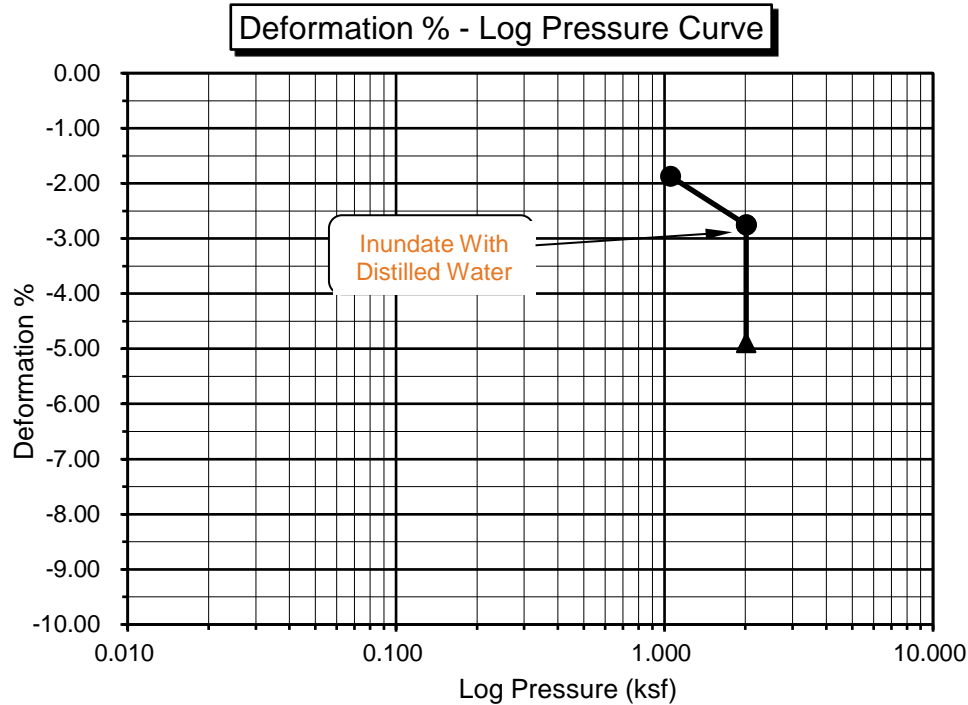



**One-Dimensional Swell or Settlement  
Potential of Cohesive Soils  
(ASTM D 4546) -- Method 'B'**

Project Name: Highpointe MV 1 Geo Tested By: M. Vinet Date: 3/21/22  
 Project No.: 13169.003 Checked By: M. Vinet Date: 3/23/22  
 Boring No.: LB-3 Sample Type: IN SITU  
 Sample No.: R-3 Depth (ft.) 7.5

Sample Description: Silty Sand (SM), Brown.  
 Source and Type of Water Used for Inundation: Arrowhead ( Distilled )

**\*\* Note:** Loading After Wetting (Inundation) not Performed Using this Test Method.

Initial Dry Density (pcf):	99.3
Initial Moisture (%):	8.9
Initial Height (in.):	1.0000
Initial Dial Reading (in):	0.0000
Inside Diameter of Ring (in):	2.416

Final Dry Density (pcf):	106.8
Final Moisture (%) :	17.6
Initial Void ratio:	0.6978
Specific Gravity (assumed):	2.70
Initial Degree of Saturation (%):	34.4

Pressure (p) (ksf)	Final Reading (in)	Apparent Thickness (in)	Load Compliance (%)	Swell (+) Settlement (-) % of Sample Thickness	Void Ratio	Corrected Deformation (%)
1.050	0.0239	0.9761	0.00	-2.39	0.6573	-2.39
2.013	0.0338	0.9662	0.00	-3.38	0.6405	-3.38
H2O	0.0703	0.9297	0.00	-7.03	0.5785	-7.03

**Percent Swell / Settlement After Inundation = -3.78**

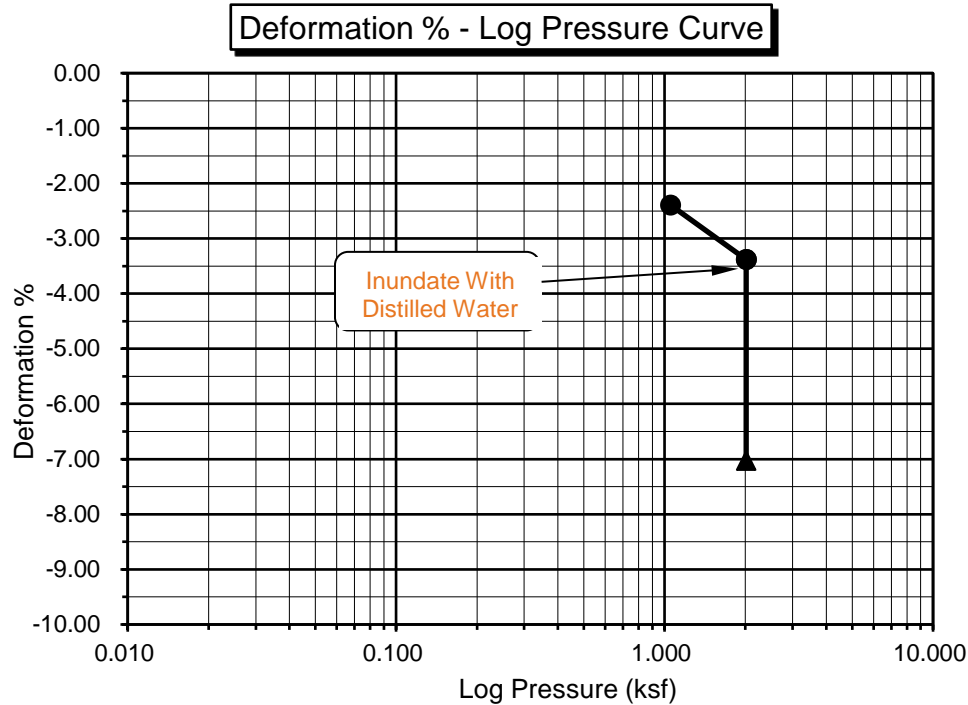



**One-Dimensional Swell or Settlement  
Potential of Cohesive Soils  
(ASTM D 4546) -- Method 'B'**

Project Name: Highpointe MV 1 Geo      Tested By: M. Vinet      Date: 3/21/22  
 Project No.: 13169.003      Checked By: M. Vinet      Date: 3/23/22  
 Boring No.: LB-3      Sample Type: IN SITU  
 Sample No.: R-4      Depth (ft.) 10.0

Sample Description: Silty Sand (SM), Brown.  
 Source and Type of Water Used for Inundation: Arrowhead ( Distilled )

**\*\* Note:** Loading After Wetting (Inundation) not Performed Using this Test Method.

Initial Dry Density (pcf):	100.1
Initial Moisture (%):	5.4
Initial Height (in.):	1.0000
Initial Dial Reading (in):	0.0000
Inside Diameter of Ring (in):	2.416

Final Dry Density (pcf):	109.1
Final Moisture (%) :	16.1
Initial Void ratio:	0.6846
Specific Gravity (assumed):	2.70
Initial Degree of Saturation (%):	21.3

Pressure (p) (ksf)	Final Reading (in)	Apparent Thickness (in)	Load Compliance (%)	Swell (+) Settlement (-) % of Sample Thickness	Void Ratio	Corrected Deformation (%)
1.050	0.0243	0.9757	0.00	-2.43	0.6437	-2.43
2.013	0.0391	0.9609	0.00	-3.91	0.6187	-3.91
H2O	0.0830	0.9170	0.00	-8.30	0.5448	-8.30

**Percent Swell / Settlement After Inundation = -4.57**

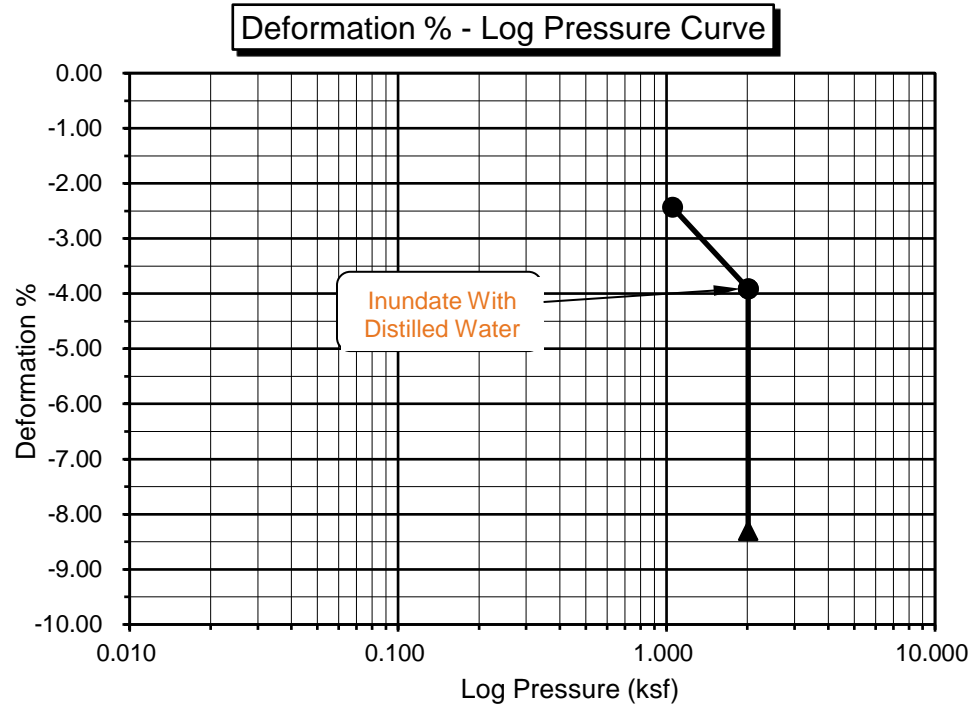



**One-Dimensional Swell or Settlement  
Potential of Cohesive Soils  
(ASTM D 4546) -- Method 'B'**

Project Name: Highpointe MV 1 Geo Tested By: M. Vinet Date: 3/22/22  
 Project No.: 13169.003 Checked By: M. Vinet Date: 3/23/22  
 Boring No.: LB-4 Sample Type: IN SITU  
 Sample No.: R-3 Depth (ft.) 7.5

Sample Description: Silty Sand (SM), Brown.  
 Source and Type of Water Used for Inundation: Arrowhead ( Distilled )

\*\* Note: Loading After Wetting (Inundation) not Performed Using this Test Method.

Initial Dry Density (pcf):	87.3
Initial Moisture (%):	7.4
Initial Height (in.):	1.0000
Initial Dial Reading (in):	0.0000
Inside Diameter of Ring (in):	2.416

Final Dry Density (pcf):	95.4
Final Moisture (%) :	25.4
Initial Void ratio:	0.9318
Specific Gravity (assumed):	2.70
Initial Degree of Saturation (%):	21.5

Pressure (p) (ksf)	Final Reading (in)	Apparent Thickness (in)	Load Compliance (%)	Swell (+) Settlement (-) % of Sample Thickness	Void Ratio	Corrected Deformation (%)
1.050	0.0096	0.9904	0.00	-0.96	0.9133	-0.96
2.013	0.0200	0.9800	0.00	-2.00	0.8932	-2.00
H2O	0.0856	0.9144	0.00	-8.56	0.7665	-8.56

**Percent Swell / Settlement After Inundation = -6.69**

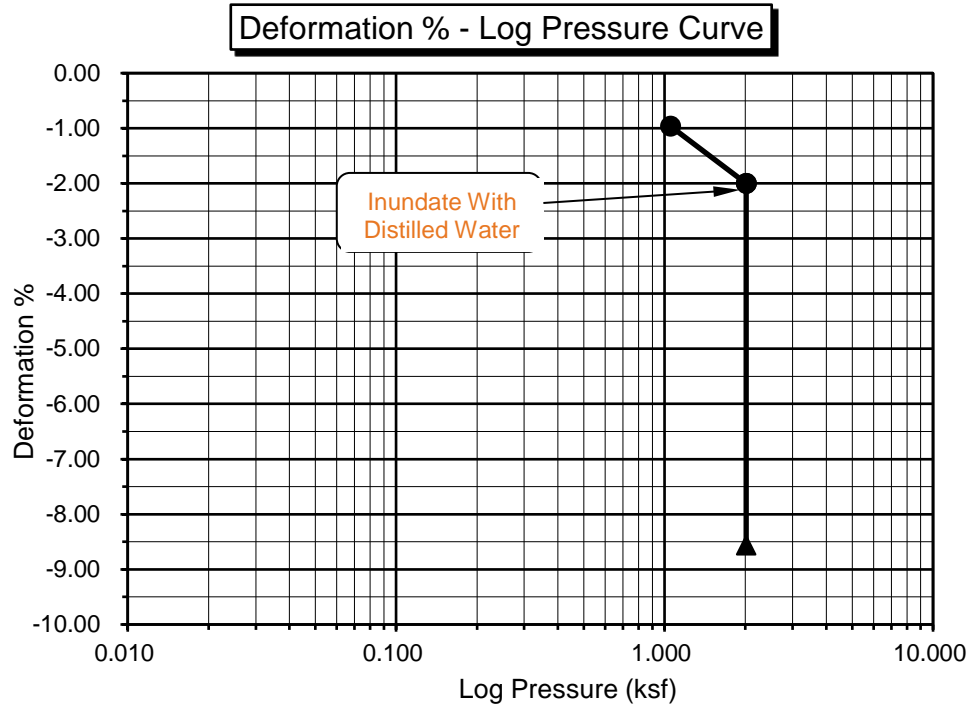



**One-Dimensional Swell or Settlement  
Potential of Cohesive Soils  
(ASTM D 4546) -- Method 'B'**

Project Name: Highpointe MV 1 Geo      Tested By: M. Vinet      Date: 3/22/22  
 Project No.: 13169.003      Checked By: M. Vinet      Date: 3/23/22  
 Boring No.: LP-1      Sample Type: IN SITU  
 Sample No.: R-2      Depth (ft.) 10.0

Sample Description: Silty Sand (SM), Brown.  
 Source and Type of Water Used for Inundation: Arrowhead ( Distilled )

**\*\* Note:** Loading After Wetting (Inundation) not Performed Using this Test Method.

Initial Dry Density (pcf):	100.6
Initial Moisture (%):	9.3
Initial Height (in.):	1.0000
Initial Dial Reading (in):	0.0000
Inside Diameter of Ring (in):	2.416

Final Dry Density (pcf):	106.0
Final Moisture (%) :	19.1
Initial Void ratio:	0.6750
Specific Gravity (assumed):	2.70
Initial Degree of Saturation (%):	37.3

Pressure (p) (ksf)	Final Reading (in)	Apparent Thickness (in)	Load Compliance (%)	Swell (+) Settlement (-) % of Sample Thickness	Void Ratio	Corrected Deformation (%)
1.050	0.0137	0.9863	0.00	-1.37	0.6520	-1.37
2.013	0.0235	0.9765	0.00	-2.35	0.6356	-2.35
H2O	0.0503	0.9497	0.00	-5.03	0.5907	-5.03

**Percent Swell / Settlement After Inundation = -2.74**

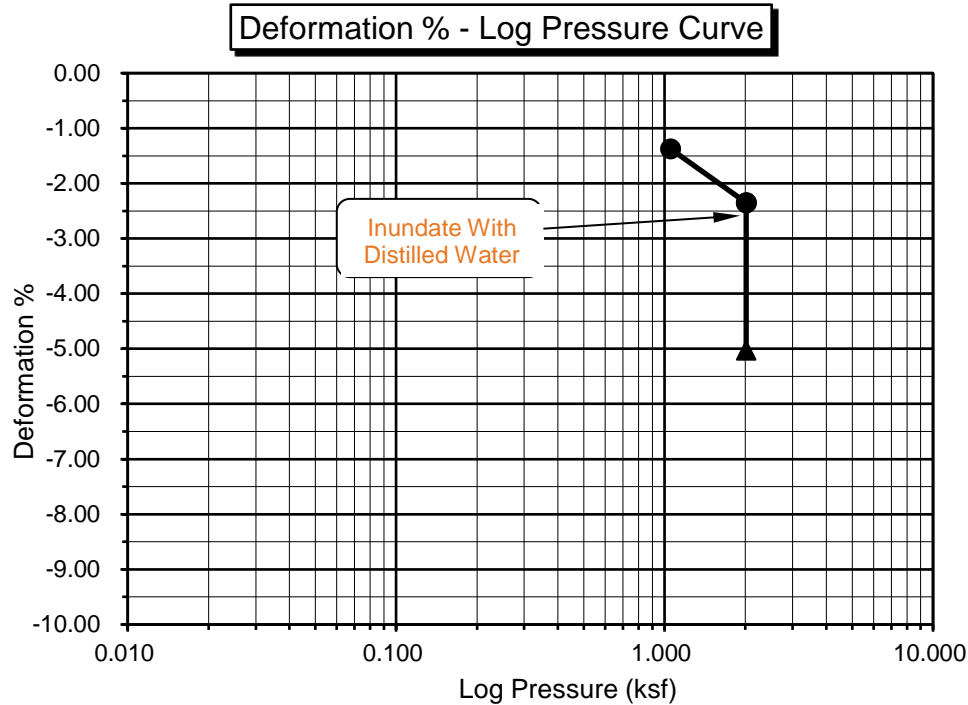



**One-Dimensional Swell or Settlement  
Potential of Cohesive Soils  
(ASTM D 4546) -- Method 'B'**

Project Name: Highpointe MV 1 Geo Tested By: M. Vinet Date: 3/22/22  
 Project No.: 13169.003 Checked By: M. Vinet Date: 3/23/22  
 Boring No.: LP-2 Sample Type: IN SITU  
 Sample No.: R-1 Depth (ft.) 5.0

Sample Description: Silty Sand (SM), Brown.  
 Source and Type of Water Used for Inundation: Arrowhead ( Distilled )

**\*\* Note:** Loading After Wetting (Inundation) not Performed Using this Test Method.

Initial Dry Density (pcf):	97.4
Initial Moisture (%):	5.5
Initial Height (in.):	1.0000
Initial Dial Reading (in):	0.0000
Inside Diameter of Ring (in):	2.416

Final Dry Density (pcf):	110.1
Final Moisture (%) :	16.8
Initial Void ratio:	0.7307
Specific Gravity (assumed):	2.70
Initial Degree of Saturation (%):	20.5

Pressure (p) (ksf)	Final Reading (in)	Apparent Thickness (in)	Load Compliance (%)	Swell (+) Settlement (-) % of Sample Thickness	Void Ratio	Corrected Deformation (%)
1.050	0.0157	0.9843	0.00	-1.57	0.7036	-1.57
2.013	0.0252	0.9748	0.00	-2.52	0.6871	-2.52
H2O	0.1155	0.8845	0.00	-11.55	0.5308	-11.55

**Percent Swell / Settlement After Inundation = -9.26**

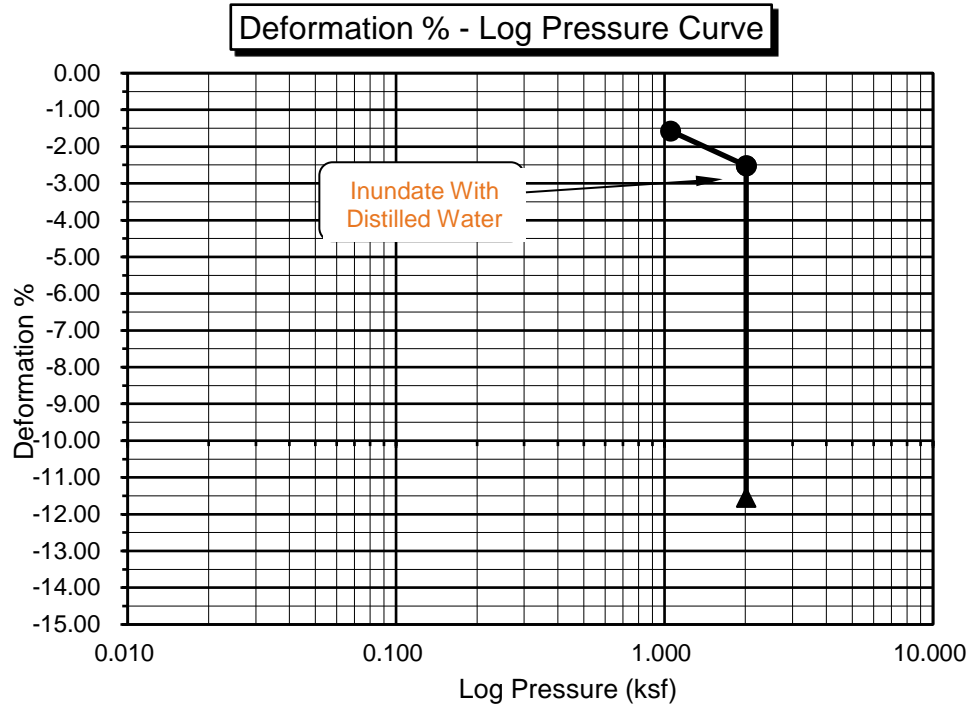





# MODIFIED PROCTOR COMPACTION TEST

ASTM D 1557

Project Name: Highpointe MV 1 Geo Tested By: F. Mina Date: 03/22/22  
 Project No.: 13169.003 Input By: M. Vinet Date: 03/23/22  
 Boring No.: LB-3 Depth (ft.): 0 - 5.0  
 Sample No.: B-1  
 Soil Identification: Silty Sand (SM), Brown.

Preparation Method:

Moist  
 Dry

Mechanical Ram  
 Manual Ram

Mold Volume (ft<sup>3</sup>)

**0.03340**

Ram Weight = 10 lb.; Drop = 18 in.

TEST NO.	1	2	3	4	5	6
Wt. Compacted Soil + Mold (g)	5523	5643	5722	5670		
Weight of Mold (g)	3539	3539	3539	3539		
Net Weight of Soil (g)	1984	2104	2183	2131		
Wet Weight of Soil + Cont. (g)	2129.7	1522.3	1602.7	1422.8		
Dry Weight of Soil + Cont. (g)	2071.9	1448.4	1502.7	1316.2		
Weight of Container (g)	716.2	277.4	280.3	276.2		
Moisture Content (%)	4.3	6.3	8.2	10.3		
Wet Density (pcf)	131.0	138.9	144.1	140.7		
Dry Density (pcf)	125.6	130.6	133.2	127.6		

Maximum Dry Density (pcf)

**133.2**

Optimum Moisture Content (%)

**8.2**

## PROCEDURE USED

**Procedure A**

Soil Passing No. 4 (4.75 mm) Sieve  
 Mold : 4 in. (101.6 mm) diameter  
 Layers : 5 (Five)  
 Blows per layer : 25 (twenty-five)  
 May be used if + #4 is 20% or less

**Procedure B**

Soil Passing 3/8 in. (9.5 mm) Sieve  
 Mold : 4 in. (101.6 mm) diameter  
 Layers : 5 (Five)  
 Blows per layer : 25 (twenty-five)  
 Use if + #4 is >20% and + 3/8 in. is 20% or less

**Procedure C**

Soil Passing 3/4 in. (19.0 mm) Sieve  
 Mold : 6 in. (152.4 mm) diameter  
 Layers : 5 (Five)  
 Blows per layer : 56 (fifty-six)  
 Use if + 3/8 in. is >20% and + 3/4 in. is <30%

## Particle-Size Distribution:

**3:65:32**

GR:SA:FI

## Atterberg Limits:

LL, PL, PI

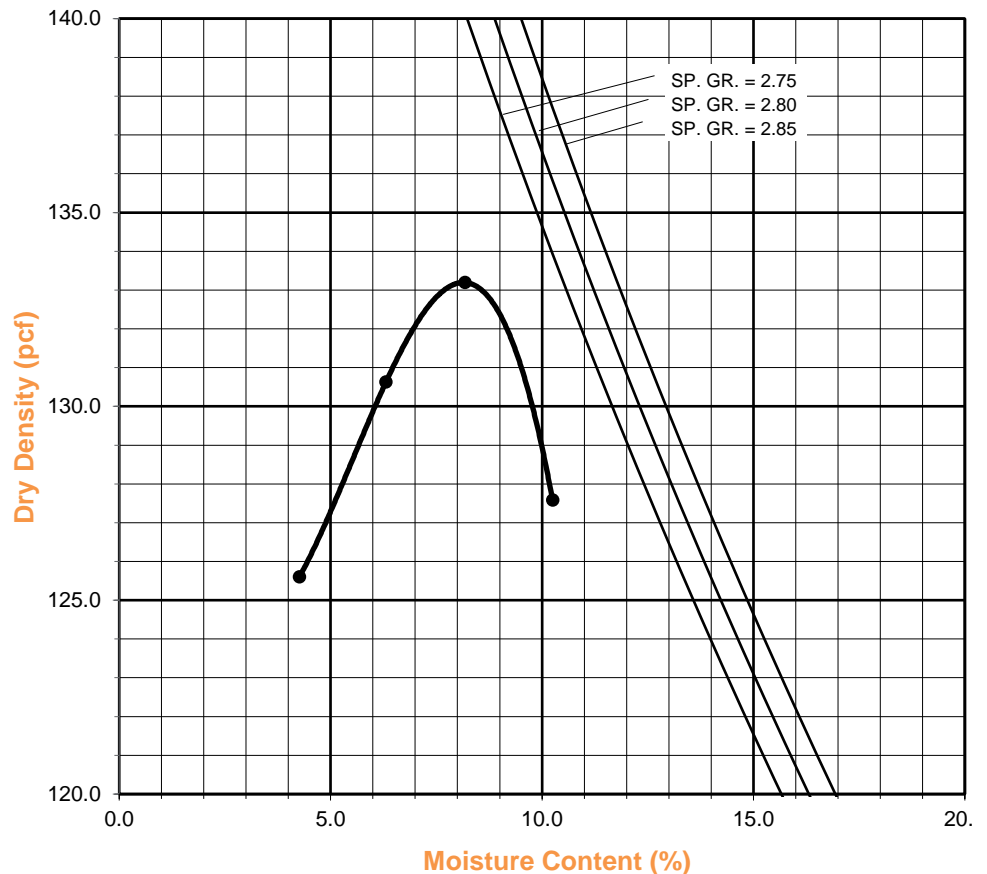

Compaction: LB-3, B-1 (03-15-22)



# MODIFIED PROCTOR COMPACTION TEST

ASTM D 1557

Project Name: Highpointe MV 1 Geo Tested By: F. Mina Date: 03/22/22  
 Project No.: 13169.003 Input By: M. Vinet Date: 03/23/22  
 Boring No.: LB-4 Depth (ft.): 0 - 5.0  
 Sample No.: B-1  
 Soil Identification: Silty Sand (SM), Brown.

Preparation Method:

Moist  
 Dry

Mechanical Ram  
 Manual Ram

Mold Volume (ft<sup>3</sup>)

**0.03340**

Ram Weight = 10 lb.; Drop = 18 in.

TEST NO.	1	2	3	4	5	6
Wt. Compacted Soil + Mold (g)	5576	5663	5684	5600		
Weight of Mold (g)	3539	3539	3539	3539		
Net Weight of Soil (g)	2037	2124	2145	2061		
Wet Weight of Soil + Cont. (g)	1289.2	1352.4	1399.2	1236.2		
Dry Weight of Soil + Cont. (g)	1231.3	1272.4	1296.4	1133.7		
Weight of Container (g)	280.1	277.8	277.0	276.4		
Moisture Content (%)	6.1	8.0	10.1	12.0		
Wet Density (pcf)	134.5	140.2	141.6	136.0		
Dry Density (pcf)	126.7	129.8	128.6	121.5		

Maximum Dry Density (pcf)

**130.0**

Optimum Moisture Content (%)

**8.5**

## PROCEDURE USED

### Procedure A

Soil Passing No. 4 (4.75 mm) Sieve  
 Mold : 4 in. (101.6 mm) diameter  
 Layers : 5 (Five)  
 Blows per layer : 25 (twenty-five)  
 May be used if + #4 is 20% or less

### Procedure B

Soil Passing 3/8 in. (9.5 mm) Sieve  
 Mold : 4 in. (101.6 mm) diameter  
 Layers : 5 (Five)  
 Blows per layer : 25 (twenty-five)  
 Use if + #4 is >20% and + 3/8 in. is 20% or less

### Procedure C

Soil Passing 3/4 in. (19.0 mm) Sieve  
 Mold : 6 in. (152.4 mm) diameter  
 Layers : 5 (Five)  
 Blows per layer : 56 (fifty-six)  
 Use if + 3/8 in. is >20% and + 3/4 in. is <30%

## Particle-Size Distribution:

**2:52:46**

GR:SA:FI

## Atterberg Limits:

LL, PL, PI

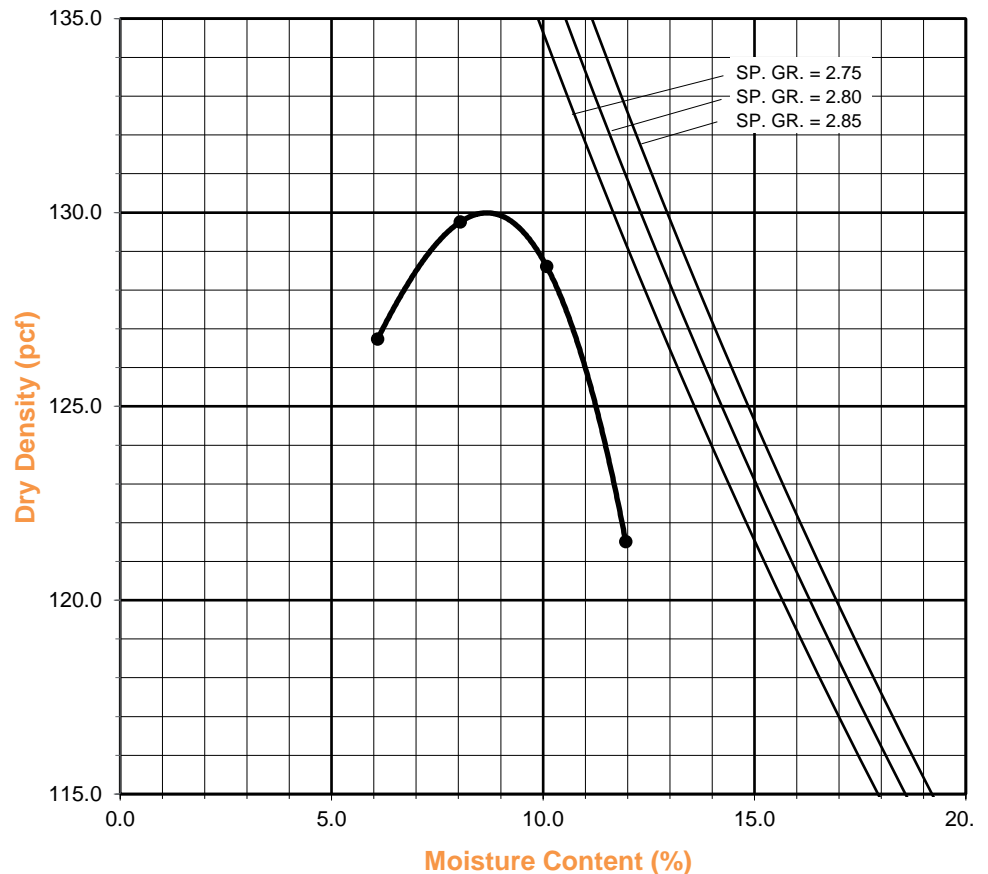

Compaction: LB-4, B-1 (03-15-22)



**TESTS for SULFATE CONTENT  
CHLORIDE CONTENT and pH of SOILS**

Project Name: Highpointe MV 1 Geo  
Project No. : 13169.003

Tested By : M. Vinet Date: 03/23/22  
Data Input By: M. Vinet Date: 03/23/22

Boring No.	LB-3			
Sample No.	B-1			
Sample Depth (ft)	0 - 5.0			
Soil Identification:	Silty Sand (SM)			
Wet Weight of Soil + Container (g)	100.00			
Dry Weight of Soil + Container (g)	100.00			
Weight of Container (g)	0.00			
Moisture Content (%)	0.00			
Weight of Soaked Soil (g)	100.00			

**SULFATE CONTENT, DOT California Test 417, Part II**

Beaker No.	1			
Crucible No.	1			
Furnace Temperature (°C)	850			
Time In / Time Out	Timer			
Duration of Combustion (min)	45			
Wt. of Crucible + Residue (g)	25.0362			
Wt. of Crucible (g)	25.0328			
Wt. of Residue (g) (A)	0.0034			
PPM of Sulfate (A) x 41150	139.91			
<b>PPM of Sulfate, Dry Weight Basis</b>	<b>140</b>			

**CHLORIDE CONTENT, DOT California Test 422**

ml of Extract For Titration (B)	30			
ml of AgNO <sub>3</sub> Soln. Used in Titration (C)	0.4			
PPM of Chloride (C -0.2) * 100 * 30 / B	20			
<b>PPM of Chloride, Dry Wt. Basis</b>	<b>20</b>			

**pH TEST, DOT California Test 643**

<b>pH Value</b>	<b>7.40</b>			
<b>Temperature °C</b>	<b>21.0</b>			

## SOIL RESISTIVITY TEST

### DOT CA TEST 643

Project Name: Highpointe MV 1 Geo

Tested By : M. Vinet Date: 03/23/22

Project No. : 13169.003

Data Input By: M. Vinet Date: 03/23/22

Boring No.: LB-3

Depth (ft.) : 0 - 5.0

Sample No. : B-1

Soil Identification:\* Silty Sand (SM)

\*California Test 643 requires soil specimens to consist only of portions of samples passing through the No. 8 US Standard Sieve before resistivity testing. Therefore, this test method may not be representative for coarser materials.

Specimen No.	Water Added (ml) (Wa)	Adjusted Moisture Content (MC)	Resistance Reading (ohm)	Soil Resistivity (ohm-cm)
1	50	10.00	8000	8000
2	83	16.60	3700	3700
3	116	23.20	2900	2900
4	149	29.80	3100	3100
5				

Moisture Content (%) (Mci)	0.00
Wet Wt. of Soil + Cont. (g)	100.00
Dry Wt. of Soil + Cont. (g)	100.00
Wt. of Container (g)	0.00
Container No.	A
Initial Soil Wt. (g) (Wt)	500.00
Box Constant	1.000
$MC = (((1 + M_{ci}/100) \times (W_a/W_t + 1)) - 1) \times 100$	

Min. Resistivity (ohm-cm)	Moisture Content (%)	Sulfate Content (ppm)	Chloride Content (ppm)	Soil pH	
				pH	Temp. (°C)
DOT CA Test 643		DOT CA Test 417 Part II		DOT CA Test 643	
<b>2900</b>	<b>23.2</b>	<b>140</b>	<b>20</b>	<b>7.40</b>	<b>21.0</b>

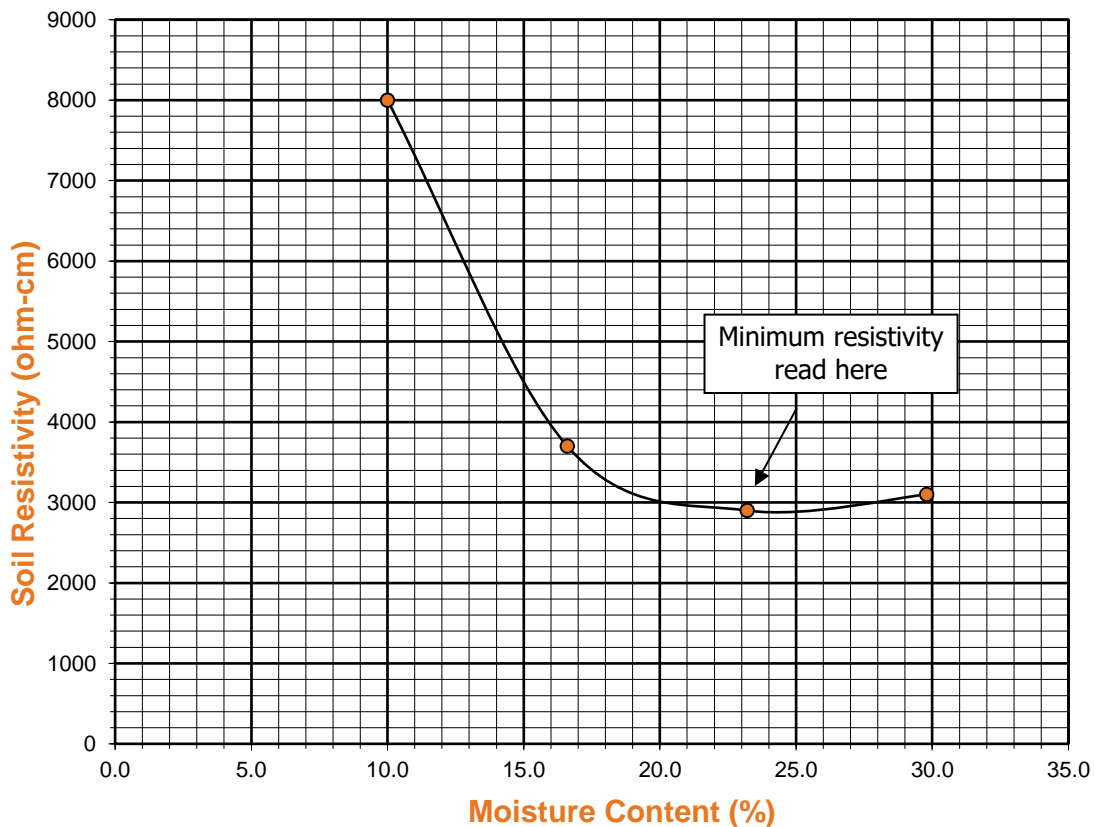



## R-VALUE TEST RESULTS

### ASTM D 2844

Project Name:	Highpointe MV 1 Geo	Date:	3/22/22
Project Number:	13169.003	Technician:	F. Mina
Boring Number:	LB-2	Depth (ft.):	0 - 5.0
Sample Number:	B-1	Sample Location:	N/A
Sample Description:	Silty Sand (SM), Brown.		

TEST SPECIMEN	A	B	C
MOISTURE AT COMPACTION %	7.9	8.4	9.4
HEIGHT OF SAMPLE, Inches	2.48	2.48	2.55
DRY DENSITY, pcf	122.3	121.3	120.2
COMPACTOR AIR PRESSURE, psi	215	200	175
EXUDATION PRESSURE, psi	646	441	286
EXPANSION, Inches x 10 <sup>exp-4</sup>	0	0	0
STABILITY Ph 2,000 lbs (160 psi)	33	48	105
TURNS DISPLACEMENT	4.50	4.75	4.90
R-VALUE UNCORRECTED	68	55	21
R-VALUE CORRECTED	68	55	21

DESIGN CALCULATION DATA	a	b	c
GRAVEL EQUIVALENT FACTOR	1.0	1.0	1.0
TRAFFIC INDEX	5.0	5.0	5.0
STABILOMETER THICKNESS, ft.	0.51	0.72	1.26
EXPANSION PRESSURE THICKNESS, ft.	0.00	0.00	0.00

EXPANSION PRESSURE CHART

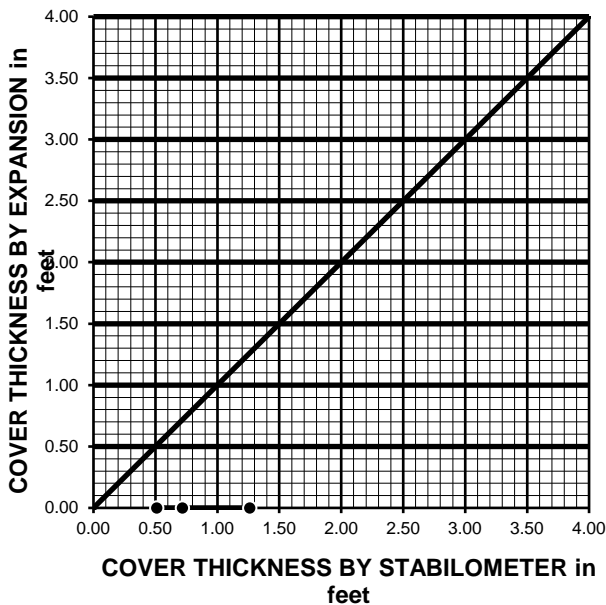

EXUDATION PRESSURE CHART

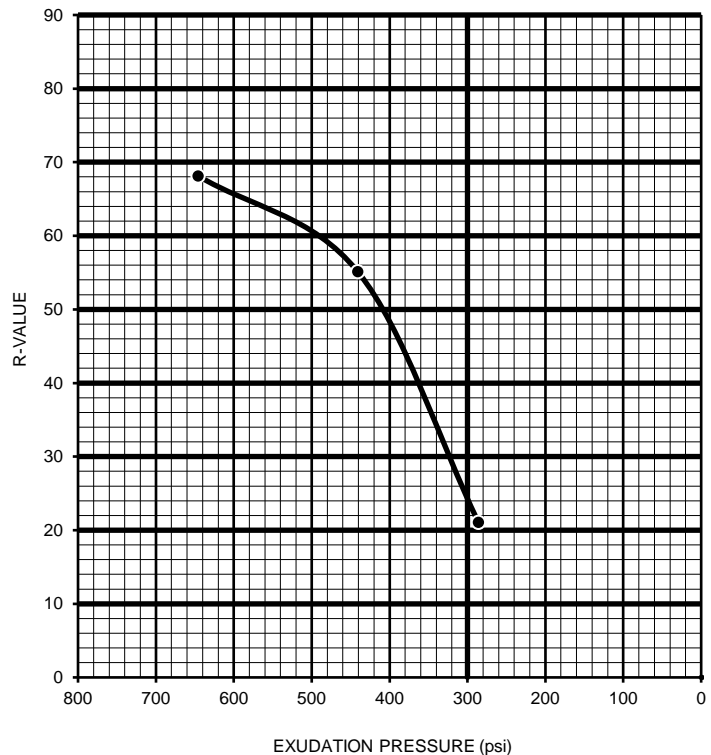

R-VALUE BY EXPANSION:	N/A
R-VALUE BY EXUDATION:	25
EQUILIBRIUM R-VALUE:	25



**PARTICLE-SIZE DISTRIBUTION (GRADATION)  
of SOILS USING SIEVE ANALYSIS  
ASTM D 6913**

Project Name: Highpointe MV 1 Geo  
 Project No.: 13169.003  
 Boring No.: LB-3  
 Sample No.: B-1  
 Soil Identification: Silty Sand (SM), Brown.

Tested By: MRV      Date: 03/23/22  
 Checked By: MRV      Date: 03/23/22  
 Depth (feet): 0 - 5.0

Calculation of Dry Weights	Whole Sample	Sample Passing #4	Moisture Contents	Whole Sample	Sample passing #4
Container No.:	P	P	Wt. of Air-Dry Soil + Cont.(g)	2129.7	1020.5
Wt. Air-Dried Soil + Cont.(g)	2189.7	1020.5	Wt. of Dry Soil + Cont. (g)	2071.9	1020.5
Wt. of Container (g)	716.2	716.2	Wt. of Container No. (g)	716.2	716.2
Dry Wt. of Soil (g)	1412.8	304.3	Moisture Content (%)	4.3	0.0

Passing #4 Material After Wet Sieve	Container No.	P
	Wt. of Dry Soil + Container (g)	930.2
	Wt. of Container (g)	716.2
	Dry Wt. of Soil Retained on # 200 Sieve (g)	214.0

U. S. Sieve Size		Cumulative Weight of Dry Soil Retained (g)		Percent Passing (%)
	(mm.)	Whole Sample	Sample Passing #4	
1 1/2"	37.500			100.0
1"	25.000			100.0
3/4"	19.000			100.0
1/2"	12.500	0.0		100.0
3/8"	9.500	12.7		99.1
#4	4.750	39.3		97.2
#8	2.360		16.6	91.9
#16	1.180		44.1	83.1
#30	0.600		74.0	73.6
#50	0.300		114.2	60.7
#100	0.150		162.6	45.3
#200	0.075		204.6	31.8
PAN				

GRAVEL: **3 %**  
 SAND: **65 %**  
 FINES: **32 %**  
 GROUP SYMBOL: **SM**

Cu = D60/D10 = N/A  
 Cc = (D30)<sup>2</sup>/(D60\*D10) = N/A

Remarks: \_\_\_\_\_

GRAVEL			SAND				FINES	
COARSE	FINE		COARSE	MEDIUM	FINE		SILT	CLAY

U.S. STANDARD SIEVE OPENING

3.0" 1 1/2" 3/4" 3/8"

U.S. STANDARD SIEVE NUMBER

#4 #8 #16 #30 #50 #100 #200

HYDROMETER

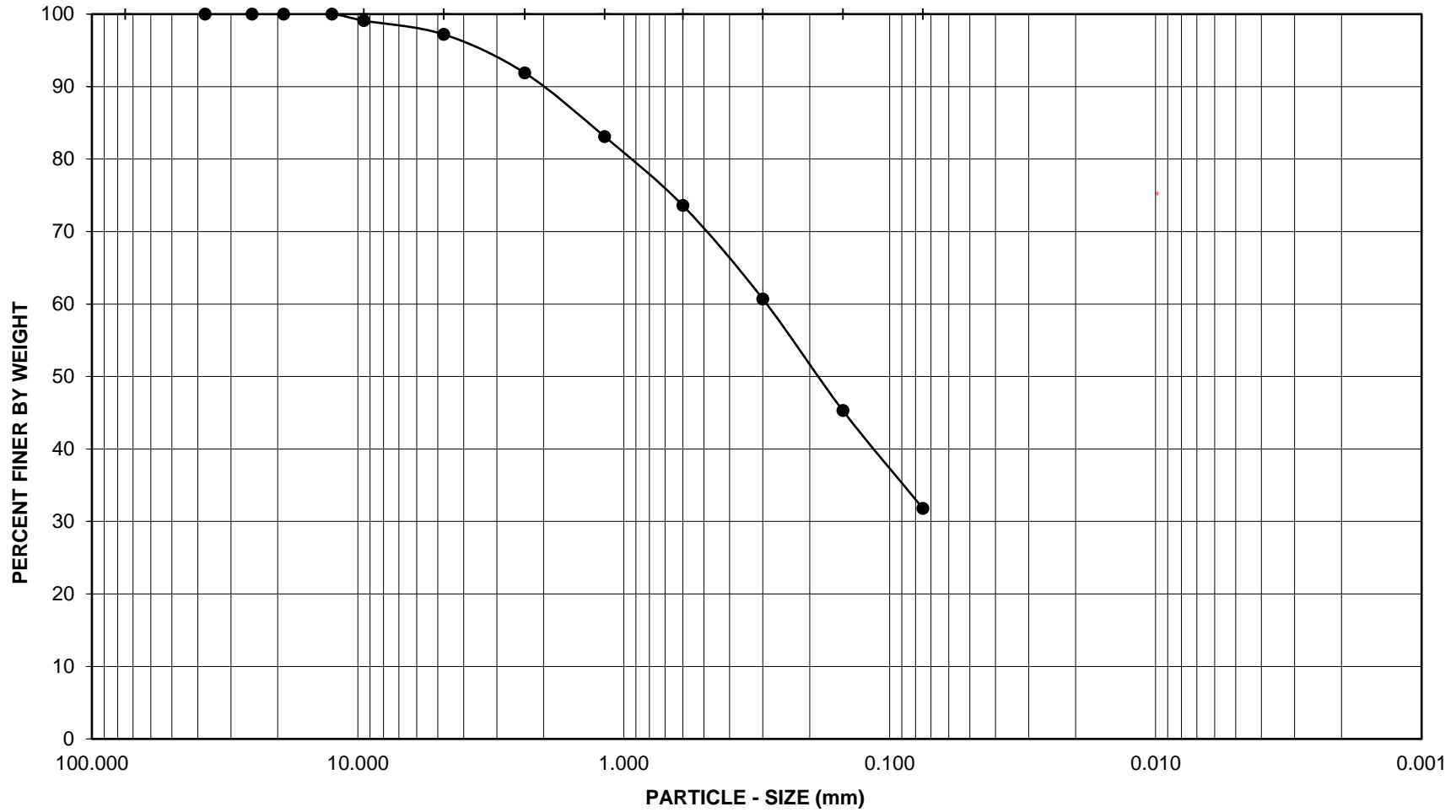

Project Name: Highpointe MV 1 Geo

Project No.: 13169.003

Boring No.: LB-3

Sample No.: B-1

Depth (feet): 0 - 5.0

Soil Type : SM

Soil Identification: Silty Sand (SM), Brown.

**GR:SA:FI : (%)      3 : 65 : 32**



**PARTICLE - SIZE  
DISTRIBUTION  
ASTM D 6913**

Mar-22



**PARTICLE-SIZE DISTRIBUTION (GRADATION)  
of SOILS USING SIEVE ANALYSIS  
ASTM D 6913**

Project Name: Highpointe MV 1 Geo  
 Project No.: 13169.003  
 Boring No.: LB-4  
 Sample No.: B-1  
 Soil Identification: Silty Sand (SM), Brown.

Tested By: MRV Date: 03/23/22  
 Checked By: MRV Date: 03/23/22  
 Depth (feet): 0 - 5.0

		Moisture Content of Total Air - Dry Soil	
Container No.:	B	Wt. of Air-Dry Soil + Cont. (g)	1107.5
Wt. of Air-Dried Soil + Cont.(g)	1107.5	Wt. of Dry Soil + Cont. (g)	1090.5
Wt. of Container (g)	673.2	Wt. of Container No._____ (g)	673.2
Dry Wt. of Soil (g)	417.3	Moisture Content (%)	4.1

After Wet Sieve	Container No.	B
	Wt. of Dry Soil + Container (g)	916.5
	Wt. of Container (g)	673.2
	Dry Wt. of Soil Retained on # 200 Sieve (g)	243.3

U. S. Sieve Size		Cumulative Weight Dry Soil Retained (g)	Percent Passing (%)
(in.)	(mm.)		
3"	75.000		100.0
1"	25.000		100.0
3/4"	19.000		100.0
1/2"	12.500		100.0
3/8"	9.500	0.0	100.0
#4	4.750	9.2	97.8
#8	2.360	22.3	94.7
#16	1.180	51.9	87.6
#30	0.600	82.5	80.2
#50	0.300	122.5	70.6
#100	0.150	173.5	58.4
#200	0.075	226.6	45.7
PAN			

GRAVEL: **2 %**  
 SAND: **52 %**  
 FINES: **46 %**  
 GROUP SYMBOL: **SM**

Cu = D60/D10 = N/A  
 Cc = (D30)<sup>2</sup>/(D60\*D10) = N/A

Remarks: \_\_\_\_\_



GRAVEL			SAND				FINES	
COARSE	FINE		COARSE	MEDIUM	FINE		SILT	CLAY

U.S. STANDARD SIEVE OPENING

3.0" 1 1/2" 3/4" 3/8"

U.S. STANDARD SIEVE NUMBER

#4 #8 #16 #30 #50 #100 #200

HYDROMETER

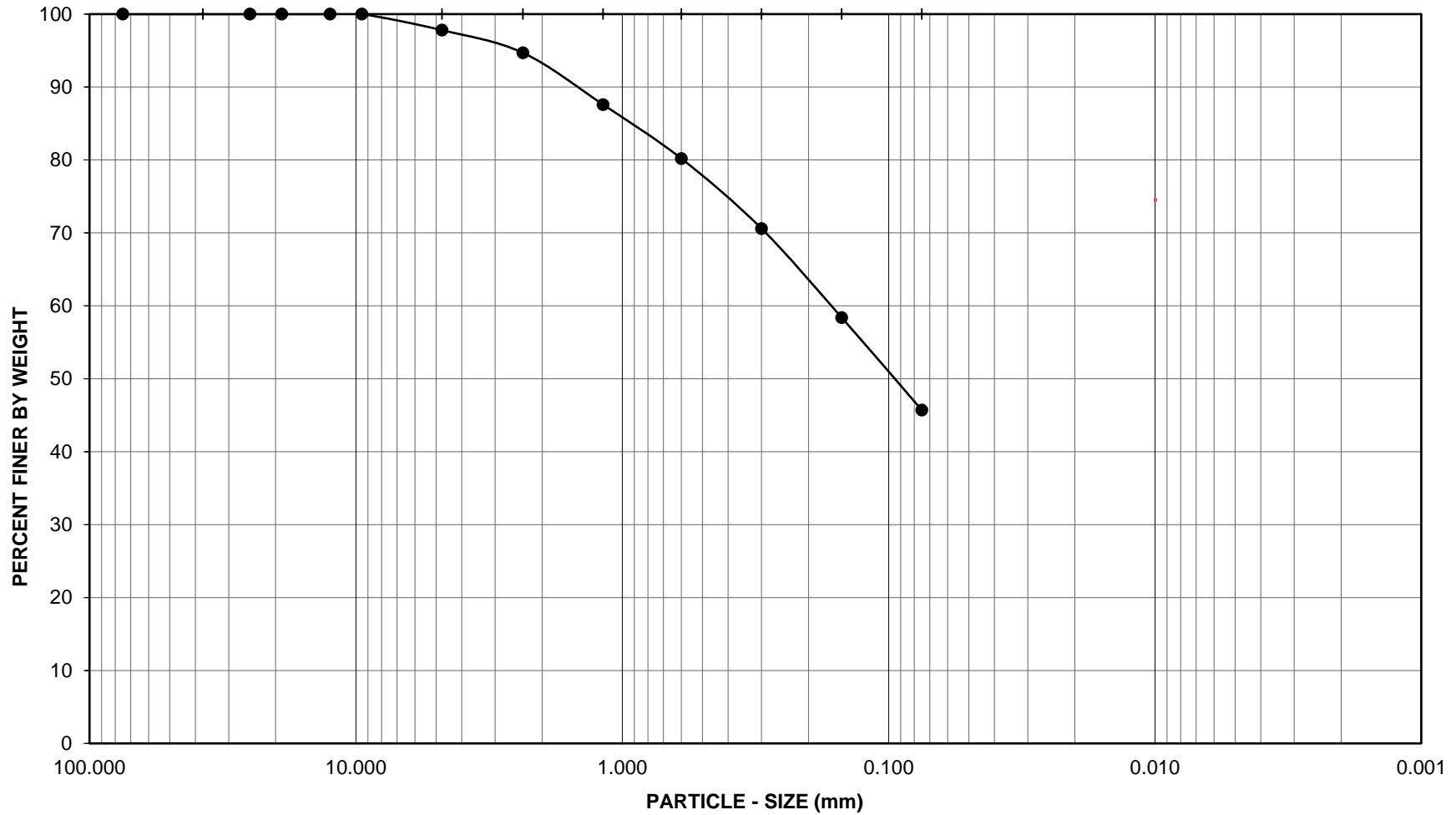

Project Name: Highpointe MV 1 Geo

Project No.: 13169.003

Boring No.: LB-4

Sample No.: B-1

Depth (feet): 0 - 5.0

Soil Type : SM

Soil Identification: Silty Sand (SM), Brown.

**GR:SA:FI : (%)      2 : 52 : 46**



**PARTICLE - SIZE  
DISTRIBUTION  
ASTM D 6913**

Mar-22

## APPENDIX C

### SEISMIC DESIGN DATA AND SETTLEMENT ANALYSES

# DRY SETTLEMENT ANALYSIS

## Highpointe MV 1

Hole No.=LB-4 Water Depth=1493 ft Surface Elev.=1593

Magnitude=7.98  
Acceleration=0.89g

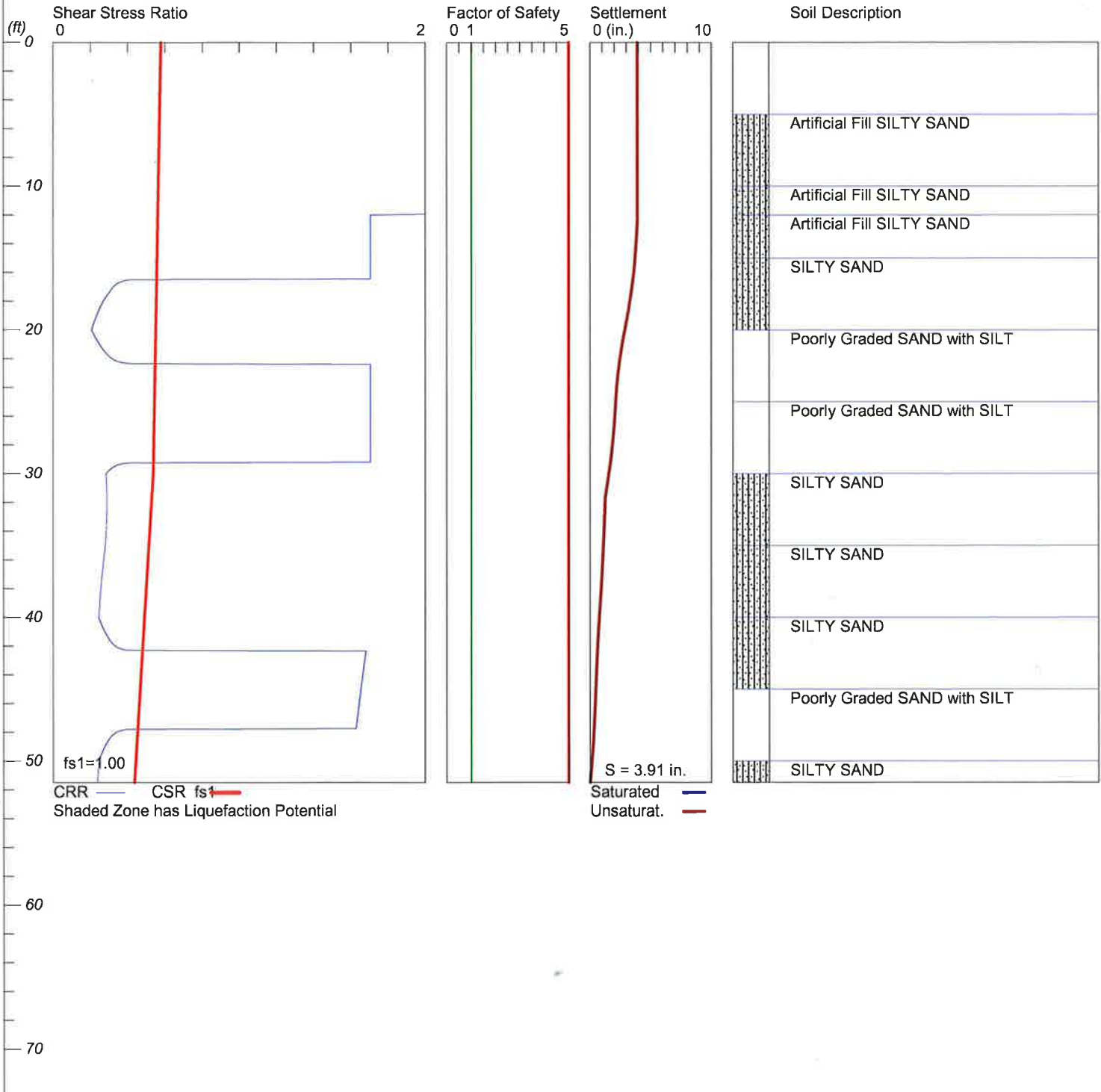

LiquefyPro CivilTech Software USA www.civiltech.com



MV-1

Latitude, Longitude: 33.9205, -117.1871

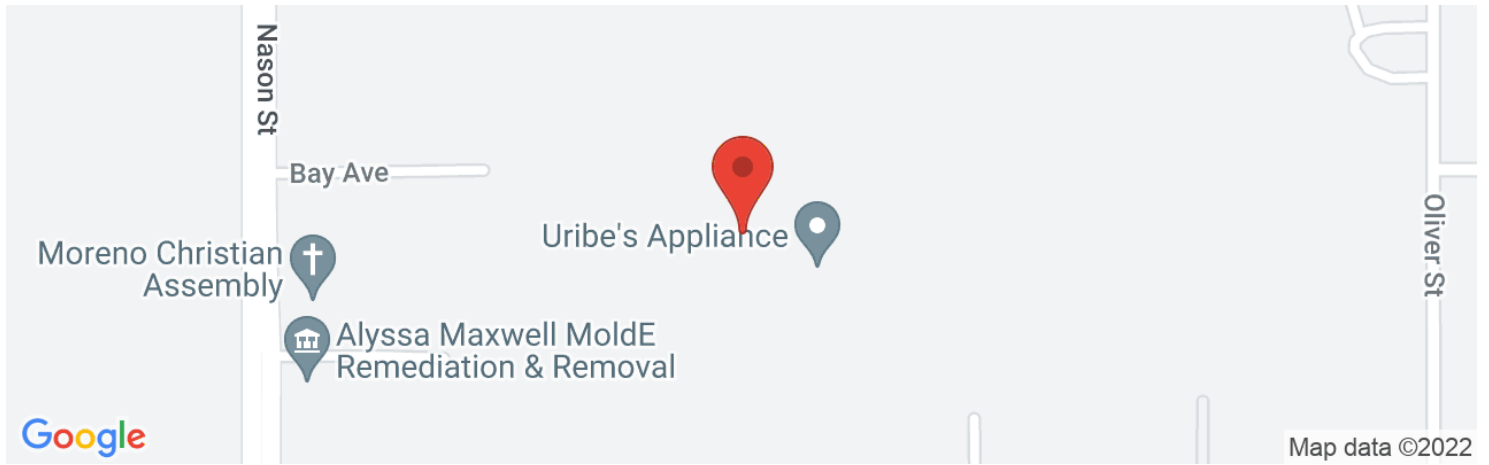

Data		5/13/2022, 12:24:08 PM
Design Code Reference Document		ASCE7-16
Risk Category		II
Site Class		D - Soft Soil
Type	Value	Description
$S_s$	1.921	MCE <sub>g</sub> ground motion (for 0.2 second period)
$S_1$	0.758	MCE <sub>g</sub> ground motion (for 1.0s period)
$F_{us}$	1.921	Site-modified spectral acceleration value
$F_{u1}$	null -See Section 11.4.8	Site-modified spectral acceleration value
$F_{05}$	1.281	Numeric seismic design value at 0.2 second SA
$F_{01}$	null -See Section 11.4.8	Numeric seismic design value at 1.0 second SA
Type	Value	Description
SDC	null -See Section 11.4.8	Seismic design category
$F_a$	1	Site amplification factor at 0.2 second
$F_v$	null -See Section 11.4.8	Site amplification factor at 1.0 second
PGA	0.811	MCE <sub>g</sub> peak ground acceleration
$F_{PGA}$	1.1	Site amplification factor at PGA
$PGA_M$	0.892	Site modified peak ground acceleration
$T_L$	8	Long-period transition period in seconds
SBRT	1.99	Probabilistic risk-targeted ground motion (0.2 second)
SDM	2.187	Factored uniform-hazard (2% probability of exceedance in 50 years) spectral acceleration
SD	1.921	Factored deterministic acceleration value (0.2 second)
SIRT	0.788	Probabilistic risk-targeted ground motion (1.0 second)
SDH	0.886	Factored uniform-hazard (2% probability of exceedance in 50 years) spectral acceleration
SD	0.758	Factored deterministic acceleration value (1.0 second)
PGA <sub>d</sub>	0.811	Factored deterministic acceleration value (Peak Ground Acceleration)
$C_{s1}$	0.91	Mapped value of the risk coefficient at short periods
$C_{s1}$	0.889	Mapped value of the risk coefficient at a period of 1 s

# Unified Hazard Tool



Please do not use this tool to obtain ground motion parameter values for the design code reference documents covered by the [U.S. Seismic Design Maps web tools](#) (e.g., the International Building Code and the ASCE 7 or 41 Standard). The values returned by the two applications are not identical.

^ Input

<b>Edition</b> Dynamic: Conterminous U.S. 2014 (update) (v4.2.0)	<b>Spectral Period</b> Peak Ground Acceleration
<b>Latitude</b> Decimal degrees 33.9205	<b>Time Horizon</b> Return period in years 2475
<b>Longitude</b> Decimal degrees, negative values for western longitudes -117.1871	
<b>Site Class</b> 360 m/s (C/D boundary)	

Hazard Curves

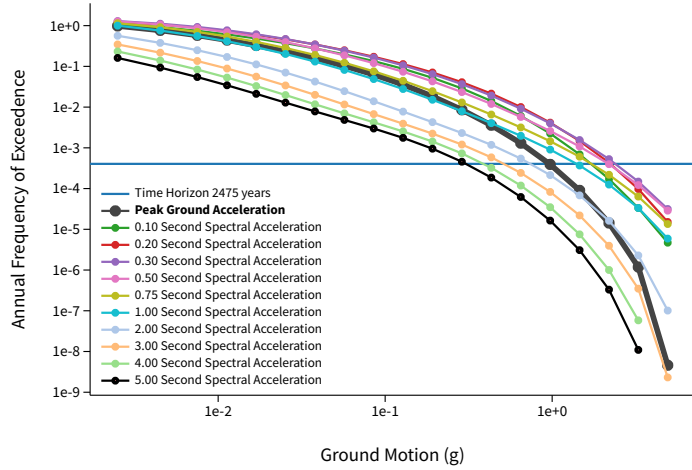

Uniform Hazard Response Spectrum

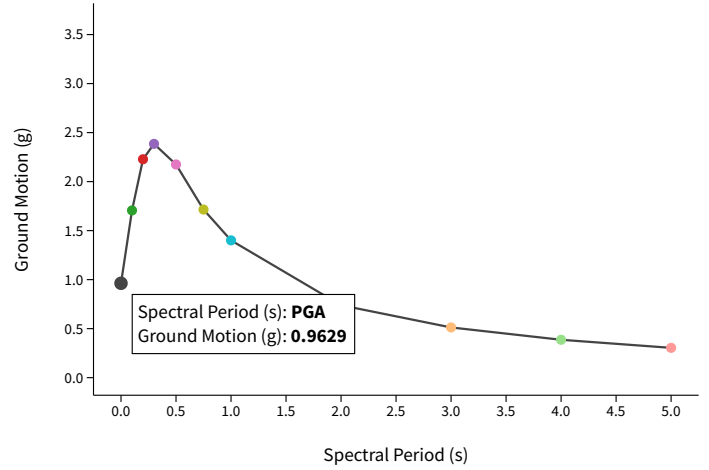

Component Curves for Peak Ground Acceleration

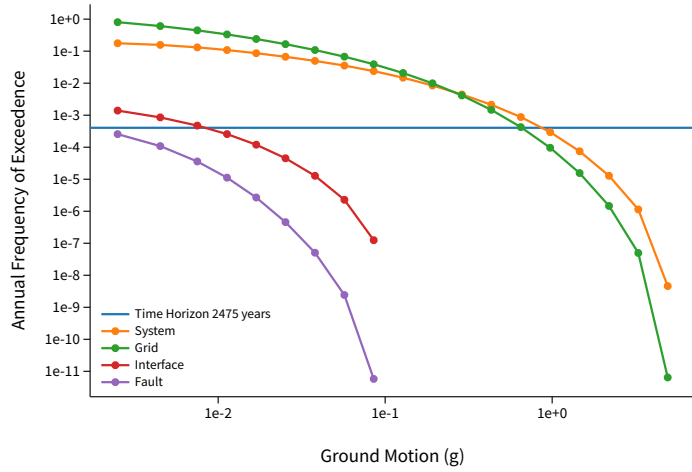

Component

Total

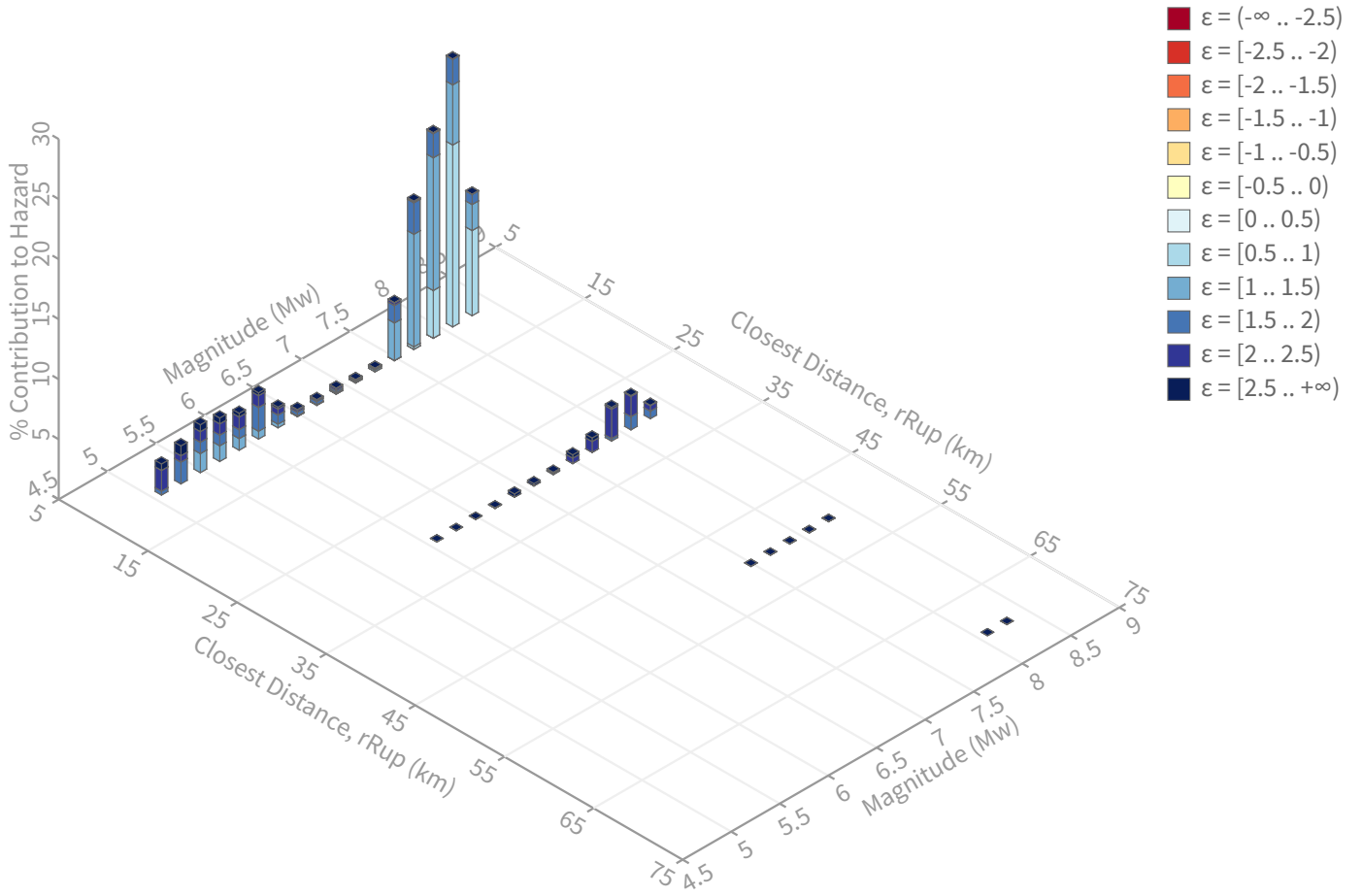

## Summary statistics for, Deaggregation: Total

### Deaggregation targets

Return period: 2475 yrs  
Exceedance rate: 0.0004040404 yr<sup>-1</sup>  
PGA ground motion: 0.96286405 g

### Totals

Binned: 100 %  
Residual: 0 %  
Trace: 0.06 %

### Mode (largest m-r bin)

m: 8.1  
r: 4.93 km  
ε: 1.09 σ  
Contribution: 22.3 %

### Discretization

r: min = 0.0, max = 1000.0, Δ = 20.0 km  
m: min = 4.4, max = 9.4, Δ = 0.2  
ε: min = -3.0, max = 3.0, Δ = 0.5 σ

### Recovered targets

Return period: 3094.6329 yrs  
Exceedance rate: 0.0003234011 yr<sup>-1</sup>

### Mean (over all sources)

m: 7.43  
r: 7.54 km  
ε: 1.43 σ

### Mode (largest m-r-ε bin)

m: 8.1  
r: 4.86 km  
ε: 0.96 σ  
Contribution: 15.15 %

### Epsilon keys

ε0: [-∞, -2.5]  
ε1: [-2.5, -2.0]  
ε2: [-2.0, -1.5]  
ε3: [-1.5, -1.0]  
ε4: [-1.0, -0.5]  
ε5: [-0.5, 0.0]  
ε6: [0.0, 0.5]  
ε7: [0.5, 1.0]  
ε8: [1.0, 1.5]  
ε9: [1.5, 2.0]  
ε10: [2.0, 2.5]  
ε11: [2.5, +∞]



Deaggregation Contributors

Source Set	Source	Type	r	m	$\epsilon_0$	lon	lat	az	%
UC130akg_FM31		System							38.31
	San Jacinto (San Jacinto Valley) rev [1]		4.86	7.98	1.11	117.152°W	33.953°N	41.48	31.54
	San Andreas (San Bernardino S) [2]		22.02	7.90	2.18	117.090°W	34.101°N	23.84	3.21
	San Geronimo Pass [2]		14.12	7.65	1.81	117.064°W	33.955°N	53.94	1.05
UC130akg_FM32		System							38.25
	San Jacinto (San Jacinto Valley) rev [1]		4.86	7.97	1.11	117.152°W	33.953°N	41.48	31.56
	San Andreas (San Bernardino S) [2]		22.02	7.90	2.18	117.090°W	34.101°N	23.94	3.34
UC130akg_FM31 (opt)		Grid							11.72
	PointSourceFIntr: -117.187, 33.943		5.75	5.58	1.69	117.187°W	33.943°N	0.00	3.23
	PointSourceFIntr: -117.187, 33.943		5.75	5.58	1.69	117.187°W	33.943°N	0.00	3.23
	PointSourceFIntr: -117.187, 33.997		9.48	5.75	2.23	117.187°W	33.997°N	0.00	1.51
	PointSourceFIntr: -117.187, 33.997		9.48	5.75	2.23	117.187°W	33.997°N	0.00	1.51
UC130akg_FM32 (opt)		Grid							11.72
	PointSourceFIntr: -117.187, 33.943		5.75	5.58	1.69	117.187°W	33.943°N	0.00	3.23
	PointSourceFIntr: -117.187, 33.943		5.75	5.58	1.69	117.187°W	33.943°N	0.00	3.23
	PointSourceFIntr: -117.187, 33.997		9.48	5.75	2.23	117.187°W	33.997°N	0.00	1.51
	PointSourceFIntr: -117.187, 33.997		9.48	5.75	2.23	117.187°W	33.997°N	0.00	1.51

## APPENDIX D

### GENERAL EARTHWORK AND GRADING SPECIFICATIONS FOR ROUGH GRADING

---

**APPENDIX D  
LEIGHTON AND ASSOCIATES, INC.  
GENERAL EARTHWORK AND GRADING SPECIFICATIONS FOR ROUGH GRADING**

**TABLE OF CONTENTS**

<b><u>Section</u></b>	<b><u>Appendix J Page</u></b>
1.0 GENERAL .....	1
1.1 Intent .....	1
1.2 The Geotechnical Consultant of Record .....	1
1.3 The Earthwork Contractor .....	2
2.0 PREPARATION OF AREAS TO BE FILLED .....	2
2.1 Clearing and Grubbing .....	2
2.2 Processing.....	3
2.3 Overexcavation .....	3
2.4 Benching .....	3
2.5 Evaluation/Acceptance of Fill Areas .....	4
3.0 FILL MATERIAL .....	4
3.1 General .....	4
3.2 Oversize .....	4
3.3 Import.....	4
4.0 FILL PLACEMENT AND COMPACTION.....	5
4.1 Fill Layers.....	5
4.2 Fill Moisture Conditioning .....	5
4.3 Compaction of Fill.....	5
4.4 Compaction of Fill Slopes.....	5
4.5 Compaction Testing.....	5
4.6 Frequency of Compaction Testing.....	6
4.7 Compaction Test Locations .....	6
5.0 SUBDRAIN INSTALLATION.....	6
6.0 EXCAVATION .....	6
7.0 TRENCH BACKFILLS .....	7
7.1 Safety .....	7
7.2 Bedding and Backfill.....	7
7.3 Lift Thickness .....	7
7.4 Observation and Testing .....	7

---

Attachments - Standard Details

A - Keying and Benching	Rear of Text
B - Oversize Rock Disposal	Rear of Text
C - Canyon Subdrains	Rear of Text
D - Buttress or Replacement Fill Subdrains	Rear of Text
E - Transition Lot Fills and Side Hill Fills	Rear of Text

## 1.0 GENERAL

### 1.1 Intent

These General Earthwork and Grading Specifications are for the grading and earthwork shown on the approved grading plan(s) and/or indicated in the geotechnical report(s). These Specifications are a part of the recommendations contained in the geotechnical report(s). In case of conflict, the specific recommendations in the geotechnical report shall supersede these more general Specifications. Observations of the earthwork by the project Geotechnical Consultant during the course of grading may result in new or revised recommendations that could supersede these specifications or the recommendations in the geotechnical report(s).

### 1.2 The Geotechnical Consultant of Record

Prior to commencement of work, the owner shall employ the Geotechnical Consultant of Record (Geotechnical Consultant). The Geotechnical Consultants shall be responsible for reviewing the approved geotechnical report(s) and accepting the adequacy of the preliminary geotechnical findings, conclusions, and recommendations prior to the commencement of the grading.

Prior to commencement of grading, the Geotechnical Consultant shall review the "work plan" prepared by the Earthwork Contractor (Contractor) and schedule sufficient personnel to perform the appropriate level of observation, mapping, and compaction testing.

During the grading and earthwork operations, the Geotechnical Consultant shall observe, map, and document the subsurface exposures to verify the geotechnical design assumptions. If the observed conditions are found to be significantly different than the interpreted assumptions during the design phase, the Geotechnical Consultant shall inform the owner, recommend appropriate changes in design to accommodate the observed conditions, and notify the review agency where required. Subsurface areas to be geotechnically observed, mapped, elevations recorded, and/or tested include natural ground after it has been cleared for receiving fill but before fill is placed, bottoms of all "remedial removal" areas, all key bottoms, and benches made on sloping ground to receive fill.

The Geotechnical Consultant shall observe the moisture-conditioning and processing of the subgrade and fill materials and perform relative compaction testing of fill to determine the attained level of compaction.

The Geotechnical Consultant shall provide the test results to the owner and the Contractor on a routine and frequent basis.

### **1.3 The Earthwork Contractor**

The Earthwork Contractor (Contractor) shall be qualified, experienced, and knowledgeable in earthwork logistics, preparation and processing of ground to receive fill, moisture-conditioning and processing of fill, and compacting fill. The Contractor shall review and accept the plans, geotechnical report(s), and these Specifications prior to commencement of grading. The Contractor shall be solely responsible for performing the grading in accordance with the plans and specifications.

The Contractor shall prepare and submit to the owner and the Geotechnical Consultant a work plan that indicates the sequence of earthwork grading, the number of "spreads" of work and the estimated quantities of daily earthwork contemplated for the site prior to commencement of grading. The Contractor shall inform the owner and the Geotechnical Consultant of changes in work schedules and updates to the work plan at least 24 hours in advance of such changes so that appropriate observations and tests can be planned and accomplished. The Contractor shall not assume that the Geotechnical Consultant is aware of all grading operations.

The Contractor shall have the sole responsibility to provide adequate equipment and methods to accomplish the earthwork in accordance with the applicable grading codes and agency ordinances, these Specifications, and the recommendations in the approved geotechnical report(s) and grading plan(s). If, in the opinion of the Geotechnical Consultant, unsatisfactory conditions, such as unsuitable soil, improper moisture condition, inadequate compaction, insufficient buttress key size, adverse weather, etc., are resulting in a quality of work less than required in these specifications, the Geotechnical Consultant shall reject the work and may recommend to the owner that construction be stopped until the conditions are rectified.

## **2.0 PREPARATION OF AREAS TO BE FILLED**

### **2.1 Clearing and Grubbing**

Vegetation, such as brush, grass, roots, and other deleterious material shall be sufficiently removed and properly disposed of in a method acceptable to the owner, governing agencies, and the Geotechnical Consultant.

The Geotechnical Consultant shall evaluate the extent of these removals depending on specific site conditions. Earth fill material shall not contain more than 1 percent of organic materials (by volume). No fill lift shall contain more than 5 percent of organic matter. Nesting of the organic materials shall not be allowed.

If potentially hazardous materials are encountered, the Contractor shall stop work in the affected area, and a hazardous material specialist shall be informed immediately for proper evaluation and handling of these materials prior to continuing to work in that area.

As presently defined by the State of California, most refined petroleum products (gasoline, diesel fuel, motor oil, grease, coolant, etc.) have chemical constituents that are considered to be hazardous waste. As such, the indiscriminate dumping or spillage of these fluids onto the ground may constitute a misdemeanor, punishable by fines and/or imprisonment, and shall not be allowed.

## **2.2 Processing**

Existing ground that has been declared satisfactory for support of fill by the Geotechnical Consultant shall be scarified to a minimum depth of 6 inches. Existing ground that is not satisfactory shall be overexcavated as specified in the following section. Scarification shall continue until soils are broken down and free of large clay lumps or clods and the working surface is reasonably uniform, flat, and free of uneven features that would inhibit uniform compaction.

## **2.3 Overexcavation**

In addition to removals and overexcavations recommended in the approved geotechnical report(s) and the grading plan, soft, loose, dry, saturated, spongy, organic-rich, highly fractured or otherwise unsuitable ground shall be overexcavated to competent ground as evaluated by the Geotechnical Consultant during grading.

## **2.4 Benching**

Where fills are to be placed on ground with slopes steeper than 5:1 (horizontal to vertical units), the ground shall be stepped or benched. Please see the Standard Details for a graphic illustration. The lowest bench or key shall be a minimum of 15 feet wide and at least 2 feet deep, into competent material as evaluated by the Geotechnical Consultant. Other benches shall be excavated a minimum height of 4 feet into competent material or as otherwise recommended by the Geotechnical

Consultant. Fill placed on ground sloping flatter than 5:1 shall also be benched or otherwise overexcavated to provide a flat subgrade for the fill.

## **2.5 Evaluation/Acceptance of Fill Areas**

All areas to receive fill, including removal and processed areas, key bottoms, and benches, shall be observed, mapped, elevations recorded, and/or tested prior to being accepted by the Geotechnical Consultant as suitable to receive fill. The Contractor shall obtain a written acceptance from the Geotechnical Consultant prior to fill placement. A licensed surveyor shall provide the survey control for determining elevations of processed areas, keys, and benches.

## **3.0 FILL MATERIAL**

### **3.1 General**

Material to be used as fill shall be essentially free of organic matter and other deleterious substances evaluated and accepted by the Geotechnical Consultant prior to placement. Soils of poor quality, such as those with unacceptable gradation, high expansion potential, or low strength shall be placed in areas acceptable to the Geotechnical Consultant or mixed with other soils to achieve satisfactory fill material.

### **3.2 Oversize**

Oversize material defined as rock, or other irreducible material with a maximum dimension greater than 8 inches, shall not be buried or placed in fill unless location, materials, and placement methods are specifically accepted by the Geotechnical Consultant. Placement operations shall be such that nesting of oversized material does not occur and such that oversize material is completely surrounded by compacted or densified fill. Oversize material shall not be placed within 10 vertical feet of finish grade or within 2 feet of future utilities or underground construction.

### **3.3 Import**

If importing of fill material is required for grading, proposed import material shall meet the requirements of Section 3.1. The potential import source shall be given to the Geotechnical Consultant at least 48 hours (2 working days) before importing begins so that its suitability can be determined and appropriate tests performed.



## **4.0 FILL PLACEMENT AND COMPACTION**

### **4.1 Fill Layers**

Approved fill material shall be placed in areas prepared to receive fill (per Section 3.0) in near-horizontal layers not exceeding 8 inches in loose thickness. The Geotechnical Consultant may accept thicker layers if testing indicates the grading procedures can adequately compact the thicker layers. Each layer shall be spread evenly and mixed thoroughly to attain relative uniformity of material and moisture throughout.

### **4.2 Fill Moisture Conditioning**

Fill soils shall be watered, dried back, blended, and/or mixed, as necessary to attain a relatively uniform moisture content at or slightly over optimum. Maximum density and optimum soil moisture content tests shall be performed in accordance with the American Society of Testing and Materials (ASTM Test Method D1557).

### **4.3 Compaction of Fill**

After each layer has been moisture-conditioned, mixed, and evenly spread, it shall be uniformly compacted to not less than 90 percent of maximum dry density (ASTM Test Method D1557). Compaction equipment shall be adequately sized and be either specifically designed for soil compaction or of proven reliability to efficiently achieve the specified level of compaction with uniformity.

### **4.4 Compaction of Fill Slopes**

In addition to normal compaction procedures specified above, compaction of slopes shall be accomplished by backrolling of slopes with sheepfoot rollers at increments of 3 to 4 feet in fill elevation, or by other methods producing satisfactory results acceptable to the Geotechnical Consultant. Upon completion of grading, relative compaction of the fill, out to the slope face, shall be at least 90 percent of maximum density per ASTM Test Method D1557.

### **4.5 Compaction Testing**

Field-tests for moisture content and relative compaction of the fill soils shall be performed by the Geotechnical Consultant. Location and frequency of tests shall be at the Consultant's discretion based on field conditions encountered. Compaction test locations will not necessarily be selected on a random basis. Test locations shall be selected to verify adequacy of compaction levels in areas that are judged to be prone to

inadequate compaction (such as close to slope faces and at the fill/bedrock benches).

#### **4.6 Frequency of Compaction Testing**

Tests shall be taken at intervals not exceeding 2 feet in vertical rise and/or 1,000 cubic yards of compacted fill soils embankment. In addition, as a guideline, at least one test shall be taken on slope faces for each 5,000 square feet of slope face and/or each 10 feet of vertical height of slope. The Contractor shall assure that fill construction is such that the testing schedule can be accomplished by the Geotechnical Consultant. The Contractor shall stop or slow down the earthwork construction if these minimum standards are not met.

#### **4.7 Compaction Test Locations**

The Geotechnical Consultant shall document the approximate elevation and horizontal coordinates of each test location. The Contractor shall coordinate with the project surveyor to assure that sufficient grade stakes are established so that the Geotechnical Consultant can determine the test locations with sufficient accuracy. At a minimum, two grade stakes within a horizontal distance of 100 feet and vertically less than 5 feet apart from potential test locations shall be provided.

### **5.0 SUBDRAIN INSTALLATION**

Subdrain systems shall be installed in accordance with the approved geotechnical report(s), the grading plan, and the Standard Details. The Geotechnical Consultant may recommend additional subdrains and/or changes in subdrain extent, location, grade, or material depending on conditions encountered during grading. All subdrains shall be surveyed by a land surveyor/civil engineer for line and grade after installation and prior to burial. Sufficient time should be allowed by the Contractor for these surveys.

### **6.0 EXCAVATION**

Excavations, as well as over-excavation for remedial purposes, shall be evaluated by the Geotechnical Consultant during grading. Remedial removal depths shown on geotechnical plans are estimates only. The actual extent of removal shall be determined by the Geotechnical Consultant based on the field evaluation of exposed conditions during grading. Where fill-over-cut slopes are to be graded, the cut portion of the slope shall be made, evaluated, and accepted by the Geotechnical Consultant prior to placement of materials for construction of the fill portion of the slope, unless otherwise recommended by the Geotechnical Consultant.

## **7.0 TRENCH BACKFILLS**

### **7.1 Safety**

The Contractor shall follow all OSHA and Cal/OSHA requirements for safety of trench excavations.

### **7.2 Bedding and Backfill**

All bedding and backfill of utility trenches shall be performed in accordance with the applicable provisions of Standard Specifications of Public Works Construction. Bedding material shall have a Sand Equivalent greater than 30 (SE>30). The bedding shall be placed to 1 foot over the top of the conduit and densified by jetting. Backfill shall be placed and densified to a minimum of 90 percent of relative compaction from 1 foot above the top of the conduit to the surface.

The Geotechnical Consultant shall test the trench backfill for relative compaction. At least one test should be made for every 300 feet of trench and 2 feet of fill.

### **7.3 Lift Thickness**

Lift thickness of trench backfill shall not exceed those allowed in the Standard Specifications of Public Works Construction unless the Contractor can demonstrate to the Geotechnical Consultant that the fill lift can be compacted to the minimum relative compaction by his alternative equipment and method.

### **7.4 Observation and Testing**

The jetting of the bedding around the conduits shall be observed by the Geotechnical Consultant.



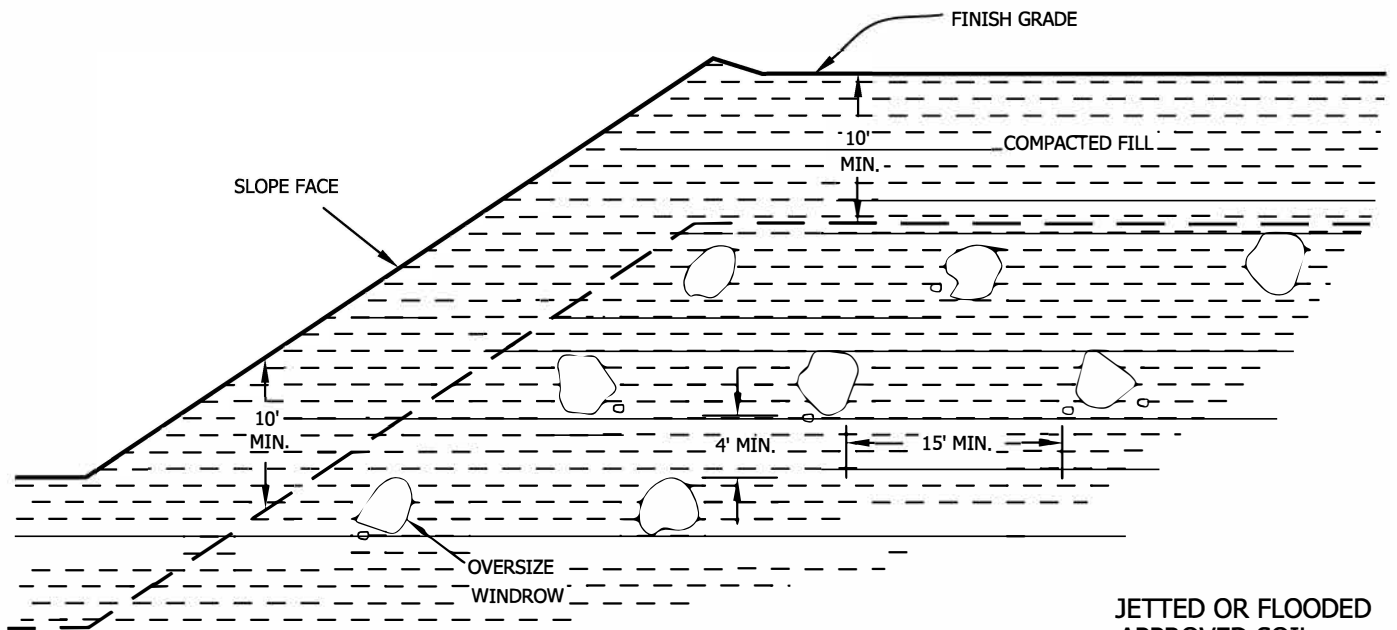

- Oversize rock is larger than 8 inches in largest dimension.
- Backfill with approved soil jetted or flooded in place to fill all the voids.
- Do not bury rock within 10 feet of finish grade.
- Windrow of buried rock shall be parallel to the finished slope face.

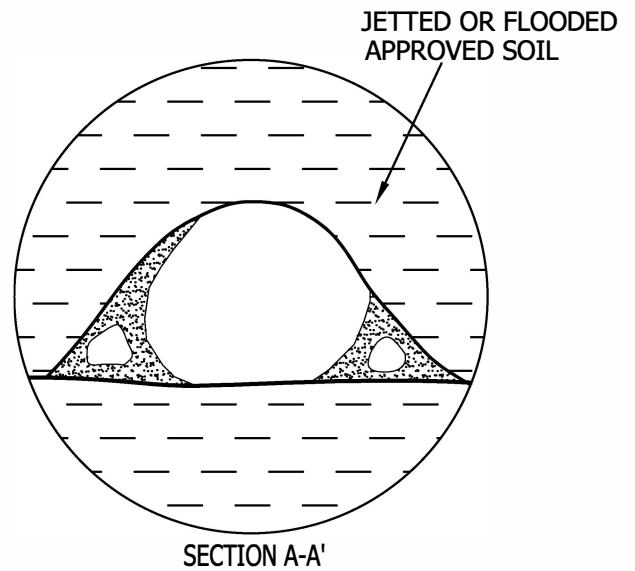

PROFILE ALONG WINDROW

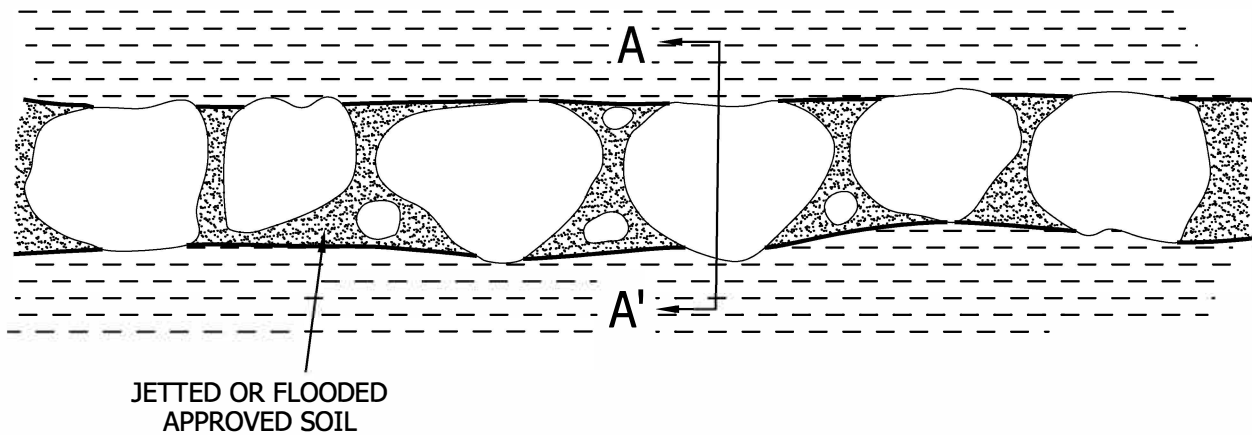

**OVERSIZE ROCK DISPOSAL**

GENERAL EARTHWORK AND GRADING  
SPECIFICATIONS  
STANDARD DETAILS B



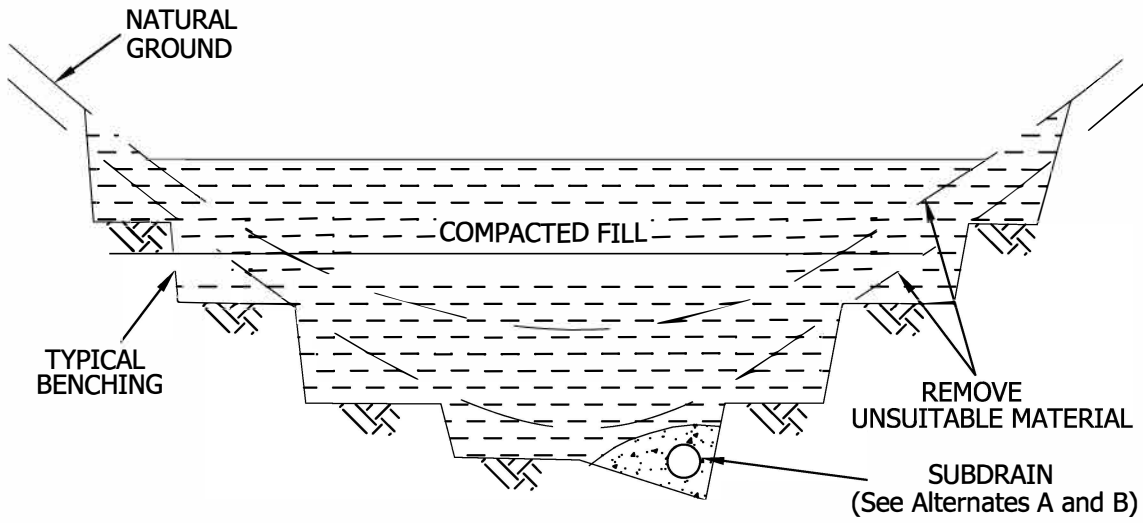

**SUBDRAIN ALTERNATE A**

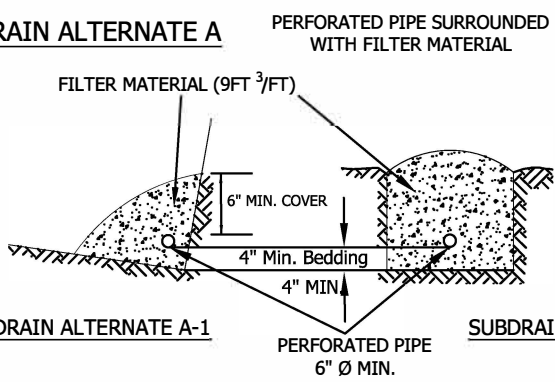

**FILTER MATERIAL**  
 FILTER MATERIAL SHALL BE CLASS 2 PERMEABLE MATERIAL PER STATE OF CALIFORNIA STANDARD SPECIFICATION, OR APPROVED ALTERNATE. CLASS 2 GRADING AS FOLLOWS:

Sieve Size	Percent Passing
1"	100
3/4"	90-100
3/8"	40-100
No. 4	25-40
No. 8	18-33
No. 30	5-15
No. 50	0-7
No. 200	0-3

**SUBDRAIN ALTERNATE A-1**

**SUBDRAIN ALTERNATE A-2**

**SUBDRAIN ALTERNATE B**

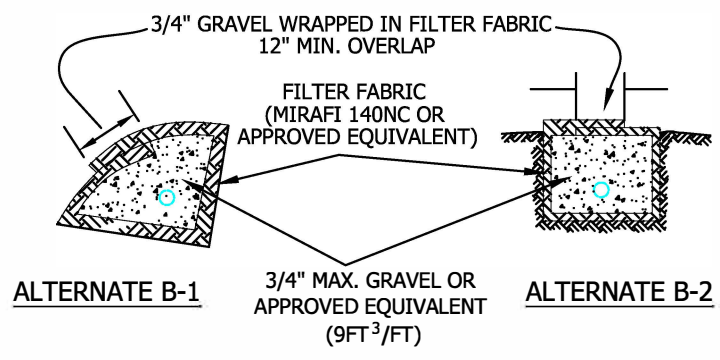

○ PERFORATED PIPE IS OPTIONAL PER GOVERNING AGENCY'S REQUIREMENTS

**DETAIL OF CANYON SUBDRAIN TERMINAL**

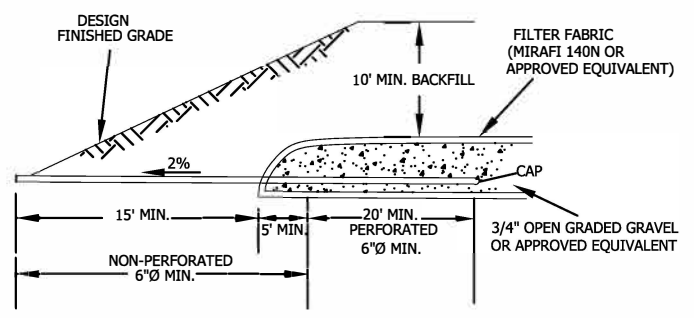

CANYON SUBDRAIN

GENERAL EARTHWORK AND GRADING SPECIFICATIONS STANDARD DETAILS C



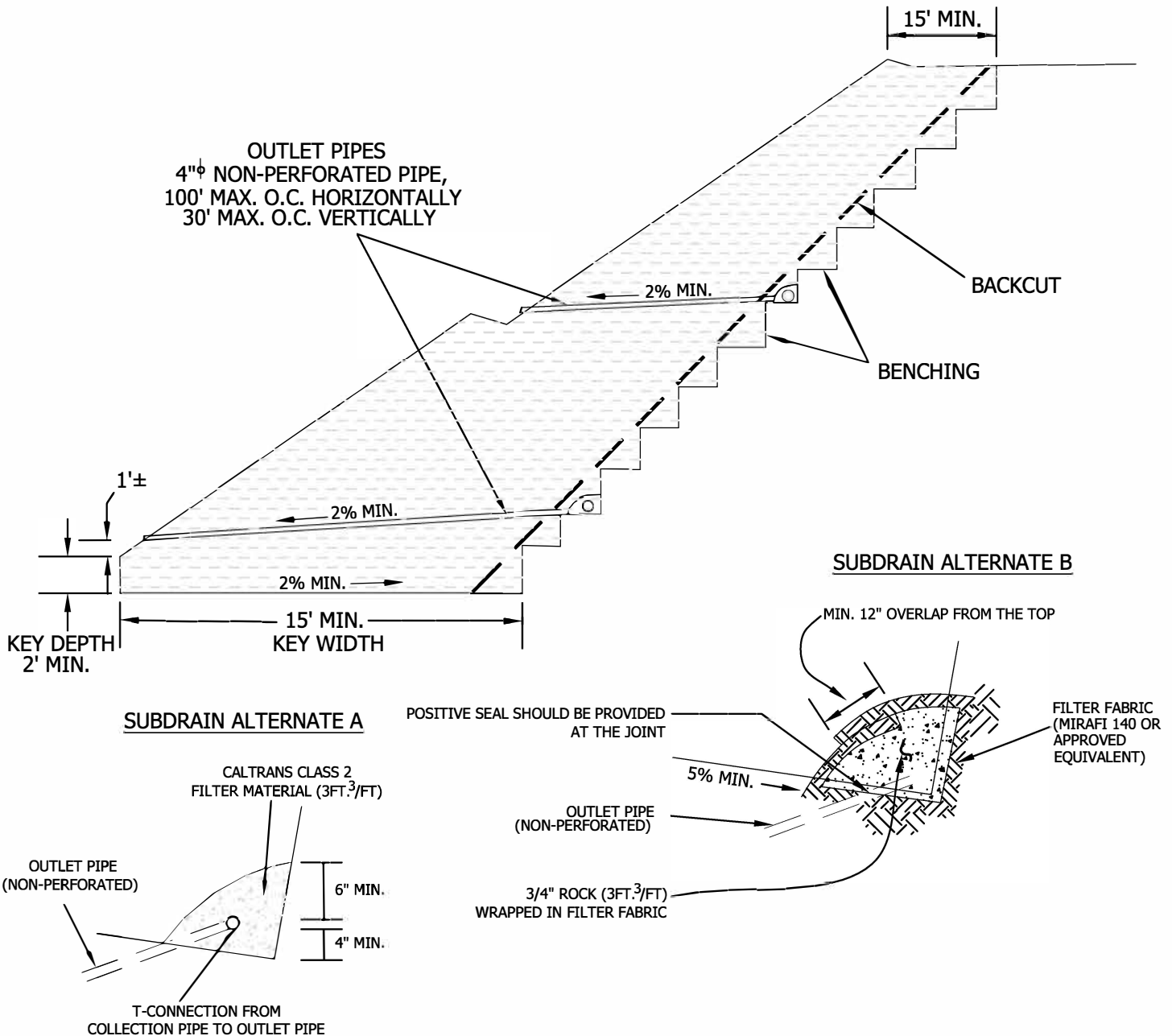

- **SUBDRAIN INSTALLATION** - Subdrain collector pipe shall be installed with perforations down or, unless otherwise designated by the geotechnical consultant. Outlet pipes shall be non-perforated pipe. The subdrain pipe shall have at least 8 perforations uniformly spaced per foot. Perforation shall be 1/4" to 1/2" if drilled holes are used. All subdrain pipes shall have a gradient at least 2% towards the outlet.
- **SUBDRAIN PIPE** - Subdrain pipe shall be ASTM D2751, ASTM D1527 (Schedule 40) or SDR 23.5 ABS pipe or ASTM D3034 (Schedule 40) or SDR 23.5 PVC pipe.
- All outlet pipe shall be placed in a trench and, after fill is placed above it, rodded to verify integrity.

**BUTTRESS OR  
REPLACEMENT FILL  
SUBDRAINS**

**GENERAL EARTHWORK AND GRADING  
SPECIFICATIONS  
STANDARD DETAILS D**



**CUT-FILL TRANSITION LOT OVEREXCAVATION**

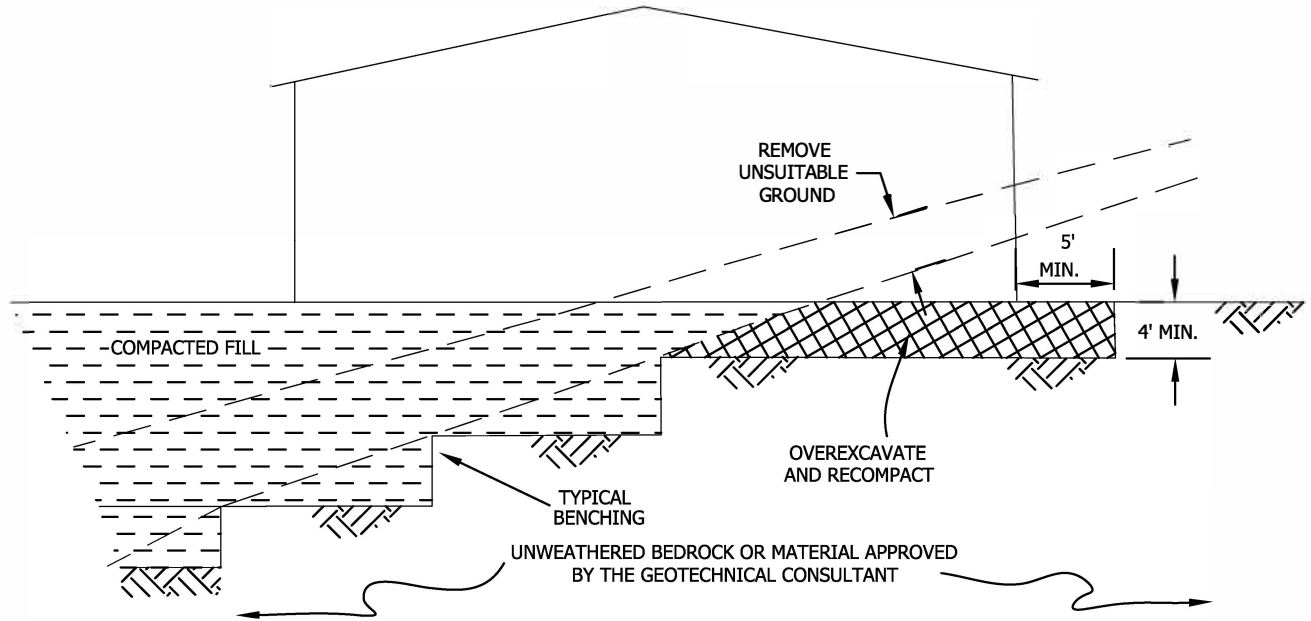

**SIDE HILL FILL FOR CUT PAD**

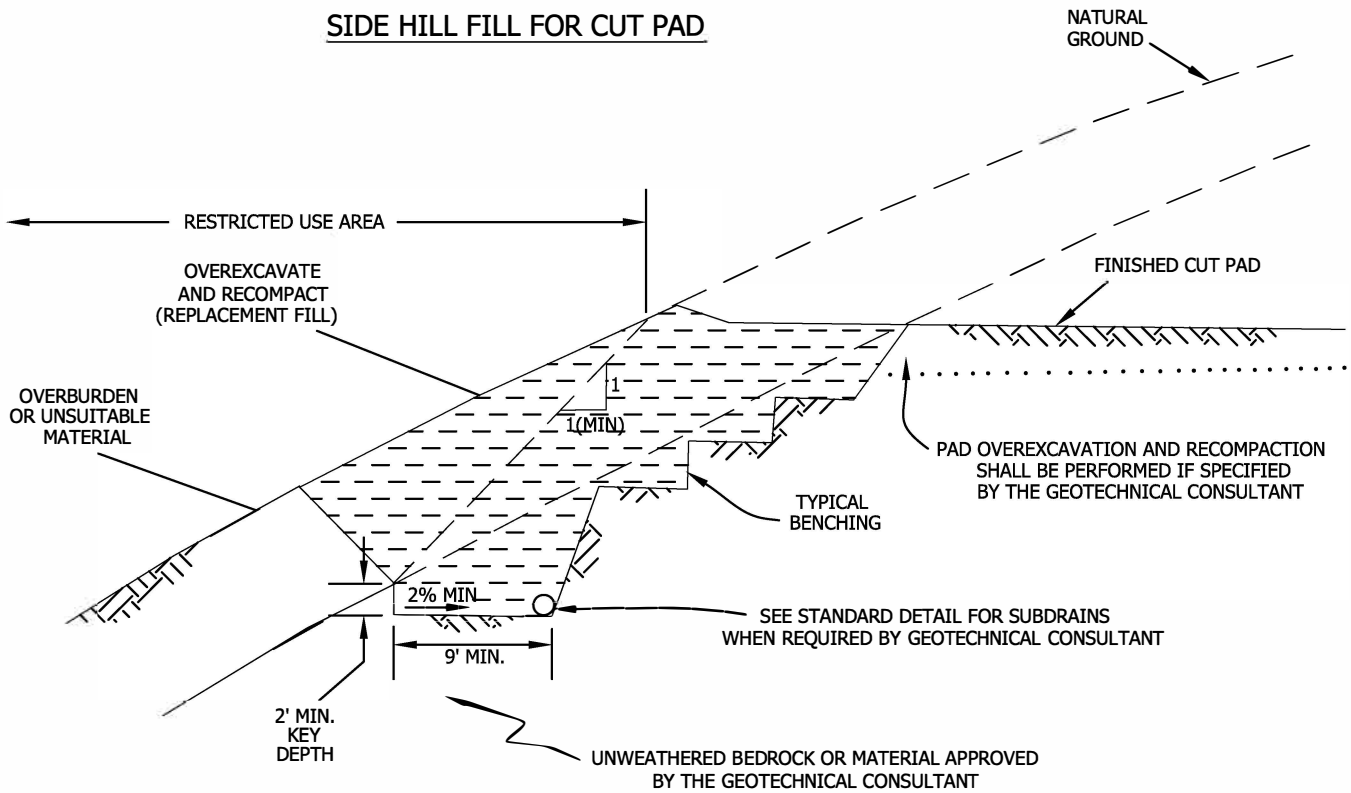

**TRANSITION LOT FILLS  
AND SIDE HILL FILLS**

**GENERAL EARTHWORK AND GRADING  
SPECIFICATIONS  
STANDARD DETAILS E**





## APPENDIX E

### RETAINING WALL BACKFILL AND SUBDRAIN DETAIL

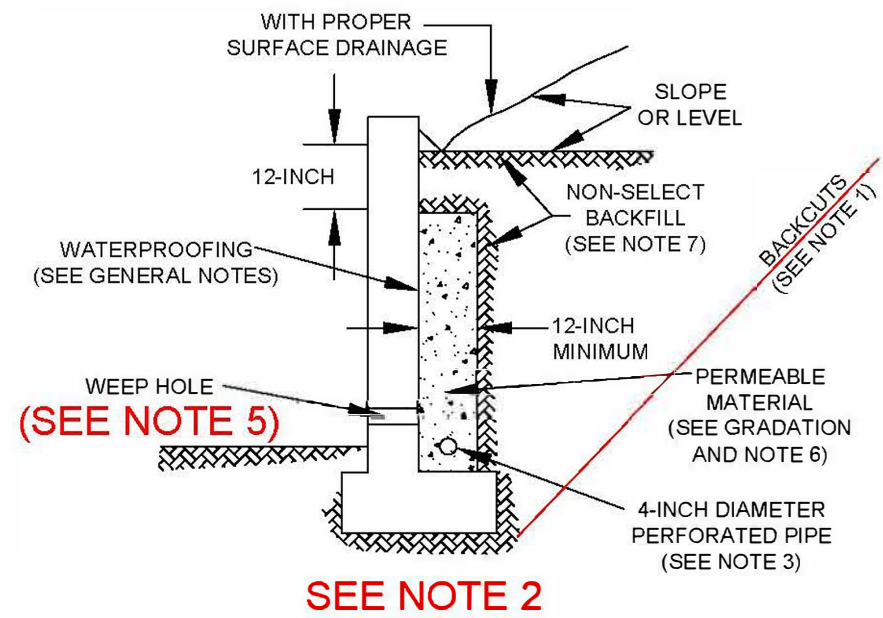

OR:

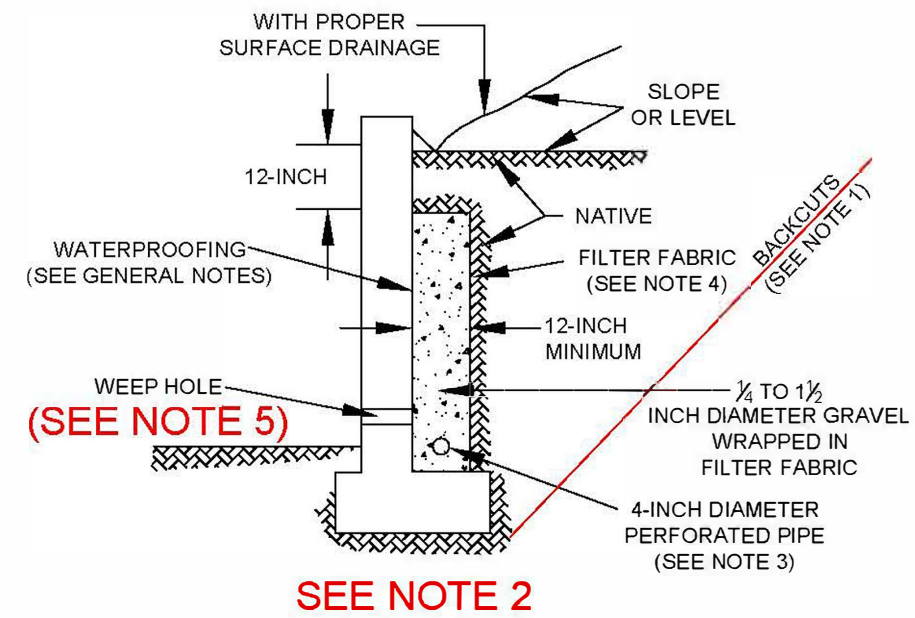

**PERMEABLE MATERIAL GRADATION:**

SIEVE SIZE	PERCENT PASSING
1-inch	100
3/4-inch	90-100
3/8-inch	40-100
No. 4	25-40
No. 8	18-33
No. 30	5-15
No. 50	0-7
No. 200	0-3

**RETAINING WALL BACKFILL AND DRAINAGE NOTES:**

- These are schematic sections, not to scale.
- Waterproofing should be provided where moisture passing through retaining walls is undesirable. Waterproofing is not observed nor inspected by Leighton Consulting, Inc.
- All subdrains should be installed with a drainage gradient of at least 1 percent.
- Outlet portion of subdrains should be solid pipe at least 4-inches in diameter, discharging into a suitable disposal area designed by the project Civil Engineer. Subdrain pipes should be accessible for maintenance (with cleanouts, etc.).

**NUMBERED NOTES KEYED TO FIGURE:**

1. **Backcuts:** Safe backcuts, in accordance with the current California Construction Safety Orders (Article 6) are required behind retaining walls to allow for Leighton Consulting, Inc. personnel to view drainage installation and to test backfill. Site safety is the responsibility of the Contractor.
2. **Foundation Bearing Surfaces:** Leighton Consulting, Inc. personnel should observe foundation bearing surfaces before reinforcing steel is placed.
3. **Perforated Pipes:** Perforated drainpipes should be either ASTM D 1527 Acrylonitrile Butadiene Styrene (ABS) or ASTM D 1785 Polyvinyl Chloride (PVC) Schedule 40 for backfill less than 15 feet deep and Schedule 80 for deeper backfill, or approved equivalent as promulgated by the project Civil Engineer. Pipe should be installed with perforations down. Perforations should be 3/8-inch diameter placed 120° radially in two-rows at 3-inch on center (staggered). Slotted pipe can be used when backfill over the pipe is less than 15 feet deep.
4. **Non-Woven Filter Fabric:** Filter fabric should be Mirafi 140NC or equivalent, conforming to Section 213-5 (Table 213-5.2 (A) 90N) of the Standard Specifications For Public Works Construction (Greenbook, 2015 Edition or more current).
5. **Weepholes:** Weepholes should be at least 3-inches in diameter and spaced no more than 10-feet on-center horizontally, at the base of retaining walls where a perforated drainpipe with gravity discharge is not provided. If exposure is permitted, weepholes should be located 12 inches above finished grade. If exposure is not permitted such as for walls adjacent to sidewalks, then a pipe under the sidewalk discharged through the curb face, or equivalent, should be provided. For basements, watertight vaults and/or reservoir walls, a proper subdrain outlet system should be provided without weepholes.
6. **Permeable Material:** At least one cubic-foot of permeable material or crushed rock should be placed per each horizontal foot of wall. Crushed rock should be wrapped in filter fabric as discussed in Note 4 (Mirafi 140NC or equivalent), above.
7. **Backfill:** All retaining wall backfill soils should have an Expansion Index (EI) <50 and should be compacted to at least 90-percent of the ASTM D 1557 laboratory maximum density, with all backfill tested by Leighton Consulting, Inc.

Proj: 12622.002	Eng/Geol: JDH/GIM
Scale: NTS	Date: February, 2020
Drafted By: MAM Checked By: V:\DRAFTING\2622\001\CAD\2019-12-02\12622-001_F07_RW_2019-12-03.DWG (12:03:19 11:29:39AM) Plotted by: btran	

**RETAINING WALL BACKFILL AND SUBDRAIN DETAIL**

Tract 5989, Harvest at Limoneira Development  
City of Santa Paula, California

Figure 2

## APPENDIX F

### GBA IMPORTANT INFORMATION ABOUT THIS GEOTECHNICAL ENGINEERING REPORT

# Important Information about This

# Geotechnical-Engineering Report

Subsurface problems are a principal cause of construction delays, cost overruns, claims, and disputes.

While you cannot eliminate all such risks, you can manage them. The following information is provided to help.

**The Geoprofessional Business Association (GBA) has prepared this advisory to help you – assumedly a client representative – interpret and apply this geotechnical-engineering report as effectively as possible. In that way, you can benefit from a lowered exposure to problems associated with subsurface conditions at project sites and development of them that, for decades, have been a principal cause of construction delays, cost overruns, claims, and disputes. If you have questions or want more information about any of the issues discussed herein, contact your GBA-member geotechnical engineer. Active engagement in GBA exposes geotechnical engineers to a wide array of risk-confrontation techniques that can be of genuine benefit for everyone involved with a construction project.**

## Understand the Geotechnical-Engineering Services Provided for this Report

Geotechnical-engineering services typically include the planning, collection, interpretation, and analysis of exploratory data from widely spaced borings and/or test pits. Field data are combined with results from laboratory tests of soil and rock samples obtained from field exploration (if applicable), observations made during site reconnaissance, and historical information to form one or more models of the expected subsurface conditions beneath the site. Local geology and alterations of the site surface and subsurface by previous and proposed construction are also important considerations. Geotechnical engineers apply their engineering training, experience, and judgment to adapt the requirements of the prospective project to the subsurface model(s). Estimates are made of the subsurface conditions that will likely be exposed during construction as well as the expected performance of foundations and other structures being planned and/or affected by construction activities.

The culmination of these geotechnical-engineering services is typically a geotechnical-engineering report providing the data obtained, a discussion of the subsurface model(s), the engineering and geologic engineering assessments and analyses made, and the recommendations developed to satisfy the given requirements of the project. These reports may be titled investigations, explorations, studies, assessments, or evaluations. Regardless of the title used, the geotechnical-engineering report is an engineering interpretation of the subsurface conditions within the context of the project and does not represent a close examination, systematic inquiry, or thorough investigation of all site and subsurface conditions.

## Geotechnical-Engineering Services are Performed for Specific Purposes, Persons, and Projects, and At Specific Times

Geotechnical engineers structure their services to meet the specific needs, goals, and risk management preferences of their clients. A geotechnical-engineering study conducted for a given civil engineer

will not likely meet the needs of a civil-works constructor or even a different civil engineer. Because each geotechnical-engineering study is unique, each geotechnical-engineering report is unique, prepared *solely* for the client.

Likewise, geotechnical-engineering services are performed for a specific project and purpose. For example, it is unlikely that a geotechnical-engineering study for a refrigerated warehouse will be the same as one prepared for a parking garage; and a few borings drilled during a preliminary study to evaluate site feasibility will not be adequate to develop geotechnical design recommendations for the project.

Do not rely on this report if your geotechnical engineer prepared it:

- for a different client;
- for a different project or purpose;
- for a different site (that may or may not include all or a portion of the original site); or
- before important events occurred at the site or adjacent to it; e.g., man-made events like construction or environmental remediation, or natural events like floods, droughts, earthquakes, or groundwater fluctuations.

Note, too, the reliability of a geotechnical-engineering report can be affected by the passage of time, because of factors like changed subsurface conditions; new or modified codes, standards, or regulations; or new techniques or tools. *If you are the least bit uncertain* about the continued reliability of this report, contact your geotechnical engineer before applying the recommendations in it. A minor amount of additional testing or analysis after the passage of time – if any is required at all – could prevent major problems.

## Read this Report in Full

Costly problems have occurred because those relying on a geotechnical-engineering report did not read the report in its entirety. Do not rely on an executive summary. Do not read selective elements only. *Read and refer to the report in full.*

## You Need to Inform Your Geotechnical Engineer About Change

Your geotechnical engineer considered unique, project-specific factors when developing the scope of study behind this report and developing the confirmation-dependent recommendations the report conveys. Typical changes that could erode the reliability of this report include those that affect:

- the site's size or shape;
- the elevation, configuration, location, orientation, function or weight of the proposed structure and the desired performance criteria;
- the composition of the design team; or
- project ownership.

As a general rule, *always* inform your geotechnical engineer of project or site changes – even minor ones – and request an assessment of their impact. *The geotechnical engineer who prepared this report cannot accept*

responsibility or liability for problems that arise because the geotechnical engineer was not informed about developments the engineer otherwise would have considered.

### Most of the “Findings” Related in This Report Are Professional Opinions

Before construction begins, geotechnical engineers explore a site’s subsurface using various sampling and testing procedures. *Geotechnical engineers can observe actual subsurface conditions only at those specific locations where sampling and testing is performed.* The data derived from that sampling and testing were reviewed by your geotechnical engineer, who then applied professional judgement to form opinions about subsurface conditions throughout the site. Actual site-wide-subsurface conditions may differ – maybe significantly – from those indicated in this report. Confront that risk by retaining your geotechnical engineer to serve on the design team through project completion to obtain informed guidance quickly, whenever needed.

### This Report’s Recommendations Are Confirmation-Dependent

The recommendations included in this report – including any options or alternatives – are confirmation-dependent. In other words, they are not final, because the geotechnical engineer who developed them relied heavily on judgement and opinion to do so. Your geotechnical engineer can finalize the recommendations *only after observing actual subsurface conditions* exposed during construction. If through observation your geotechnical engineer confirms that the conditions assumed to exist actually do exist, the recommendations can be relied upon, assuming no other changes have occurred. *The geotechnical engineer who prepared this report cannot assume responsibility or liability for confirmation-dependent recommendations if you fail to retain that engineer to perform construction observation.*

### This Report Could Be Misinterpreted

Other design professionals’ misinterpretation of geotechnical-engineering reports has resulted in costly problems. Confront that risk by having your geotechnical engineer serve as a continuing member of the design team, to:

- confer with other design-team members;
- help develop specifications;
- review pertinent elements of other design professionals’ plans and specifications; and
- be available whenever geotechnical-engineering guidance is needed.

You should also confront the risk of constructors misinterpreting this report. Do so by retaining your geotechnical engineer to participate in prebid and preconstruction conferences and to perform construction-phase observations.

### Give Constructors a Complete Report and Guidance

Some owners and design professionals mistakenly believe they can shift unanticipated-subsurface-conditions liability to constructors by limiting the information they provide for bid preparation. To help prevent the costly, contentious problems this practice has caused, include the complete geotechnical-engineering report, along with any attachments or appendices, with your contract documents, *but be certain to note*

*conspicuously that you’ve included the material for information purposes only.* To avoid misunderstanding, you may also want to note that “informational purposes” means constructors have no right to rely on the interpretations, opinions, conclusions, or recommendations in the report. Be certain that constructors know they may learn about specific project requirements, including options selected from the report, *only* from the design drawings and specifications. Remind constructors that they may perform their own studies if they want to, and *be sure to allow enough time* to permit them to do so. Only then might you be in a position to give constructors the information available to you, while requiring them to at least share some of the financial responsibilities stemming from unanticipated conditions. Conducting prebid and preconstruction conferences can also be valuable in this respect.

### Read Responsibility Provisions Closely

Some client representatives, design professionals, and constructors do not realize that geotechnical engineering is far less exact than other engineering disciplines. This happens in part because soil and rock on project sites are typically heterogeneous and not manufactured materials with well-defined engineering properties like steel and concrete. That lack of understanding has nurtured unrealistic expectations that have resulted in disappointments, delays, cost overruns, claims, and disputes. To confront that risk, geotechnical engineers commonly include explanatory provisions in their reports. Sometimes labeled “limitations,” many of these provisions indicate where geotechnical engineers’ responsibilities begin and end, to help others recognize their own responsibilities and risks. *Read these provisions closely.* Ask questions. Your geotechnical engineer should respond fully and frankly.

### Geoenvironmental Concerns Are Not Covered

The personnel, equipment, and techniques used to perform an environmental study – e.g., a “phase-one” or “phase-two” environmental site assessment – differ significantly from those used to perform a geotechnical-engineering study. For that reason, a geotechnical-engineering report does not usually provide environmental findings, conclusions, or recommendations; e.g., about the likelihood of encountering underground storage tanks or regulated contaminants. *Unanticipated subsurface environmental problems have led to project failures.* If you have not obtained your own environmental information about the project site, ask your geotechnical consultant for a recommendation on how to find environmental risk-management guidance.

### Obtain Professional Assistance to Deal with Moisture Infiltration and Mold

While your geotechnical engineer may have addressed groundwater, water infiltration, or similar issues in this report, the engineer’s services were not designed, conducted, or intended to prevent migration of moisture – including water vapor – from the soil through building slabs and walls and into the building interior, where it can cause mold growth and material-performance deficiencies. Accordingly, *proper implementation of the geotechnical engineer’s recommendations will not of itself be sufficient to prevent moisture infiltration.* **Confront the risk of moisture infiltration** by including building-envelope or mold specialists on the design team. **Geotechnical engineers are not building-envelope or mold specialists.**



Telephone: 301/565-2733

e-mail: [info@geoprofessional.org](mailto:info@geoprofessional.org) [www.geoprofessional.org](http://www.geoprofessional.org)